

BlowerDoor GmbH
MessSysteme für Luftdichtheit



BlowerDoor MiniFan

Minneapolis BlowerDoor
Model DuctBlaster B with DG-1000
TECTITE Express 5.1





THE ENERGY CONSERVATORY

Minneapolis BlowerDoor
manufactured by The Energy Conservatory, Minneapolis, MN, USA



Sole Agency for Europe, Springe-Eldagsen, Germany

Copyrighted and published by

BlowerDoor GmbH
MessSysteme für Luftdichtheit
Zum Energie- und Umweltzentrum 1
D-31832 Springe-Eldagsen

Phone +49 5044 975-40
Fax +49 5044 975-44
info@blowerdoor.com
www.blowerdoor.com

All rights reserved. This Reference Guide including all illustrations is copyright protected. Any use beyond the scope of use granted by copyright law without prior approval of the publishers is unlawful and can be prosecuted. This particularly applies to copying, translating, microfilming, as well as storing and processing in electronic systems.

Table of Contents

Safety Instructions	7
1 Introduction: The Measurement System BlowerDoor MiniFan	9
1.1 Overview: Setup with communication link via WiFi connection	9
1.2 Overview: Setup with communication link via USB connection.....	10
1.3 Applications	11
2 Installation	12
2.1 System Requirements	12
2.2 Installing Software TECTITE Express	12
2.3 Installing the Pressure Gauge DG-1000	13
2.3.1 Installing the DG-1000 using USB-C port.....	15
2.3.2 Wireless connection of the DG-1000 (WiFi).....	17
2.3.2.1 Connection via the build-in WiFi module	17
2.3.2.2 Connection to an existing WiFi network.....	20
2.3.3 Installing the DG-1000 using Ethernet port	23
2.3.4 Testing whether TECTITE Express recognizes the DG-1000	26
3 Components of BlowerDoor MiniFan Measurement System.....	29
3.1 Measuring fan and speed controller.....	29
3.2 DG-1000	30
3.2.1 Overview of the DG-1000.....	31
3.2.2 Applications.....	31
3.3 Mounting frame and panel.....	32

4	Installing the BlowerDoor MiniFan System	33
4.1	Installing the tubing for measuring outside pressure.....	34
4.2	Installing the mounting frame and panel	35
4.3	Installing the BlowerDoor fan, flow rings, and speed controller.....	39
4.3.1	Changing the flow rings.....	39
4.3.2	View of open fan	40
4.3.3	View of fan with flow rings 1, 2, 3, and 4	40
4.4	Connecting tubing to BlowerDoor panel and measuring fan	42
4.4.1	Depressurization measurement.....	42
4.4.2	Pressurization measurement	42
4.4.3	Depressurization and pressurization measurement with ring 4	43
4.5	Connecting the Pressure Gauge DG-1000	43
4.5.1	Power supply for the DG-1000.....	43
4.5.2	Connecting the DG-1000 to the fan speed controller	44
4.5.3	Connecting the DG-1000 to a laptop.....	44
4.5.4	Connecting the tubing to the DG-1000	45
4.6	Overview of the Negative Pressure Test and Positive Pressure Test	46
4.6.1	Overview of the negative pressure test / depressurization measurement	46
4.6.2	Overview of the positive pressure test / pressurization measurement.....	47
5	Computer-Controlled Tests with TECTITE Express.....	48
5.1	Leakage Detection at Constant Negative Pressure with TECTITE Express.....	53
5.2	Taking a Series of Measurements with TECTITE Express.....	55
5.2.1	Automated Measurement.....	55
5.2.2	Semi-automated Measurement.....	58

6	Creating a test report.....	60
6.1	Detailed Test Report	61
6.2	Test Graph.....	62
6.3	Creating a PDF File of the Test Reports	62
6.4	Putting Business Name and Logo on the Reports.....	63
7	Leakage Detection Using the DG-1000’s Cruise Control (without laptop).....	64
7.1	Conducting the Test.....	65
7.2	Notes on the DG-1000 Display.....	70
7.2.1	Display of air flow at 50 Pascal	70
7.2.2	Display of other specific values on channel B	70
7.2.3	Input of building area and building volume	70
	Appendix A: Technical Data	73
A.1	Minneapolis BlowerDoor MiniFan (with DuctBlaster B fan) and controller	73
A.2	Pressure Gauge DG-1000.....	74
A.3	Software TECTITE Express.....	75
A.4	BlowerDoor Mounting Frame and BlowerDoor Panel.....	76
	Appendix B: Calibration, Maintenance, and Care.....	77
B.1	DG-1000	77
	Software-Update	77
	Calibration.....	79
	Safety, warnings and troubleshooting information.....	79
	Lithium-ion batteries (rechargeable).....	79
	Touch screen – use and care	81
	Maintenance.....	81

B.2	BlowerDoor Fan	82
	Calibration parameters for DuctBlaster B and rings	82
	Calibration.....	83
	Minimal fan pressure of rings	83
	Maintenance.....	83
	Testing the motor position	84
	Testing the flow sensor.....	84
	Cleaning the fan	85
B.3	Fan Speed Controller	86
Appendix C: Expansion Capabilities of the BlowerDoor Measurement System.....		87
Our Service Offer		93
Guarantee		95
EC-Declaration of Conformity		97

Safety Instructions

Please follow all safety instructions provided when used with any BlowerDoor products.



The BlowerDoor DuctBlaster B fan (ventilator of BlowerDoor MiniFan system) should only be connected to a properly installed and tested power supply. In case of emergencies, disconnect the power cord from the AC power mains outlet. During installation, use the nearest readily accessible power outlet and keep all objects away from interfering with access to the outlet.

- Disconnect the power plug from the BlowerDoor fan receptacle before examining or making any adjustments to the fan motor, blades or electrical components.
- The BlowerDoor fan is a very powerful and potentially dangerous piece of equipment if not used and maintained properly. Carefully examine the fan before each use. If the fan housing, fan guards, blade, controller or cords become damaged, do not operate the fan until repairs have been made. Repairs should only be made by qualified repair personnel.
- If you notice any unusual noises or vibrations, stop and unplug the fan. If you can't find the source of the problem, contact the manufacturer/distributor. Make sure that there is sufficient clearance between the tips of the fan blades and the fan housing. Examine the motor for excessive dust build-up. Use a vacuum to remove the dust, or blow out the dust with compressed air.
- Keep people, animals, and objects away from the BlowerDoor fan when it is operating.
- Press the power plug firmly into the power receptacle on the BlowerDoor fan, and the AC power mains outlet. Failure to do so can cause overheating of the power cord and possible damage.
- Do not use ungrounded outlets or adapter plugs. Never remove or modify the grounding prong. Use only approved and inspected electrical wiring and connections. If using a power extension cord, use an extension cord with a core cross section of at least 1.5 mm² (i.e. type H07 RRF).
- Do not operate the BlowerDoor fan if the motor, controller or any of the electrical connections are wet. Recommended for indoor use only.
- Before connecting the speed controller to the fan, be sure that the toggle switch of the controller is at zero and that the control knob is turned completely to the left (counterclockwise).
- The operator should wear hearing protection when in close proximity to the fan operating at high speed.

- During an airtightness test, the building envelope and the BlowerDoor mounting frame experience a force of up to 5 kg/m². In order to withstand this force, the mounting frame must be installed properly, otherwise it may pop out of the door opening. The mounting frame must be reinstalled if the pressure loosens it. Once properly installed, the mounting frame can easily withstand pressures of up to 100 Pa.
- Keep the area around the fan clear of obstacles. Maintain a clearance of 1 to 2 meters around the fan so that nothing obstructs the air flow into and out of the fan. Also keep at least 30 cm free to the sides of the fan air intake. The operator should stand to the side of the fan rather than directly in front of it in order to prevent obstructions to air flow.
- Open flames in boilers, fireplaces, and furnaces must be extinguished before starting the test. Any open flame during the test is a potential fire hazard. Additionally, the fan could suck smoke or other by-products of the flame into the building, creating a safety hazard. Fireplaces that share a chimney with the area being tested may not be in operation during the test.
- Equipment safety measures may be compromised if the BlowerDoor system is used in a manner other than recommended in this document, and the BlowerDoor system operation manual.

1 Introduction: The Measurement System BlowerDoor MiniFan

1.1 Overview: Setup with communication link via WiFi connection

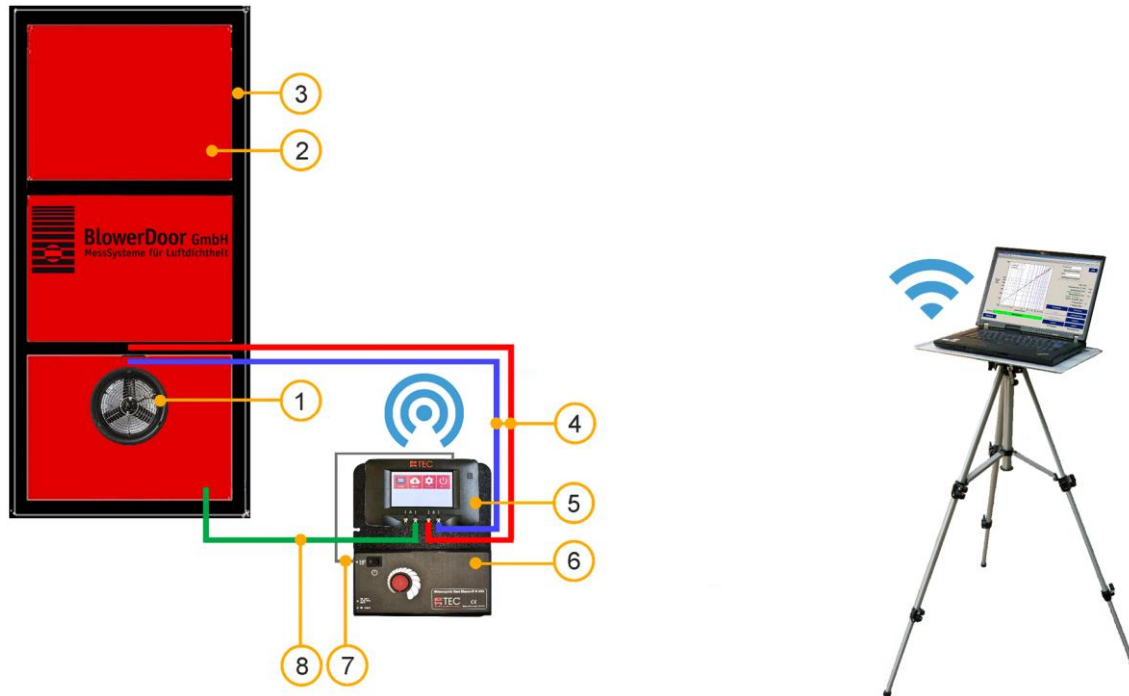

- | | |
|--|---|
| 1 BlowerDoor DuctBlaster B fan | 6 Fan speed controller for DuctBlaster B fan |
| 2 BlowerDoor panel standard size | 7 Fan control cable [connection DG-1000 – controller] |
| 3 BlowerDoor mounting frame standard size | 8 Set of tubes [capture outside pressure, inside green (3 m), outside transparent (10 m)] |
| 4 Set of tubes [connection fan – DG-1000, red and blue (3 m each)] | |
| 5 Pressure gauge DG-1000 | |

Fig. 1.1: Recommended set-up of the Measurement System BlowerDoor MiniFan with pressure gauge DG-1000 (here: WiFi connection); for details see chap. 2.3.2.1 and chap. 4.

1.2 Overview: Setup with communication link via USB connection

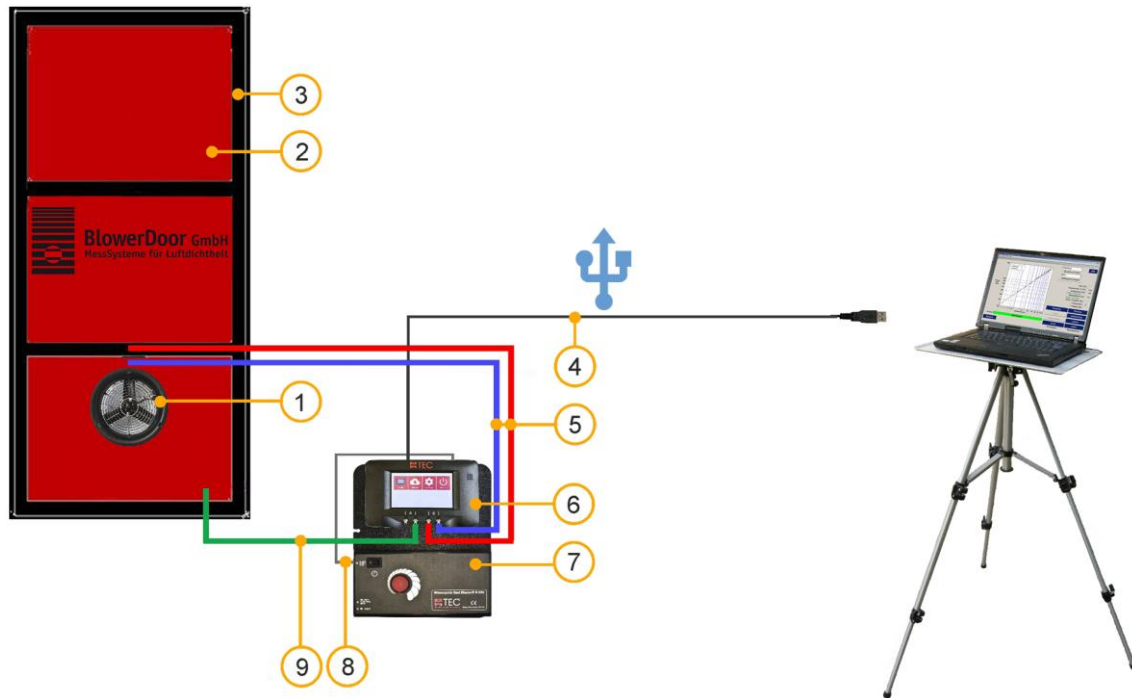

- | | | | |
|---|--|---|---|
| 1 | BlowerDoor DuctBlaster B fan | 6 | Pressure gauge DG-1000 |
| 2 | BlowerDoor panel standard size | 7 | Fan speed controller for DuctBlaster B fan |
| 3 | BlowerDoor mounting frame standard size | 8 | Fan control cable [connection DG-1000 – controller] |
| 4 | USB-data cable [DG-1000 – laptop] | 9 | Set of tubes [capture outside pressure, inside green (3 m), outside transparent (10 m)] |
| 5 | Set of tubes [connection fan – DG-1000, red and blue (3 m each)] | | |

Fig. 1.2: Set-up of the Measurement System BlowerDoor MiniFan with USB connection between pressure gauge DG-1000 and laptop computer; for details see chap. 2.3.1 and chap. 4.

1.3 Applications

The BlowerDoor measurement system is a diagnostic tool used to assess the airtightness of buildings.

Typical uses:

- Assessing airtightness respectively air permeability in new buildings and comparing the results with legal requirements such as the Energy Conservation Act
- Locating leaks during construction (of single family homes, apartments, schools, gymnasiums, etc.)
- Assessing the leakiness of old buildings prior to renovation
- Quality assurance and airtightness testing in passive houses
- Special testing-for clean rooms (operating rooms, laboratories), etc.

2 Installation

2.1 System Requirements

Operating system

TECTITE Express software and drivers run on computers with a full version of the following operating systems:

- Windows 7
- Windows 8
- Windows 10
- Windows 11

Computer

The computer/notebook/laptop must meet the following requirements:

- Pentium 233-MHZ-Processor
- 512 MB RAM
- Internet connection for USB port driver installation of DG-1000
- USB-A port (2.0 or above) or Ethernet port or WLAN port
- The connected computer is required to comply with IEC 60950-1 or equivalent standards on data port electrical safety isolation.

2.2 Installing Software TECTITE Express

TECTITE Express is a steering program. With it, you can control the BlowerDoor measurement system over a computer as well as conduct automated tests. This software must be installed.

For the automated and semi-automated BlowerDoor measurement, you also need to install the pressure gauge DG-1000 (→ Chap. 2.3) in addition to the TECTITE Express software.

The software installation is performed in the following steps:

- After the software download, double-click the file **“TECTITE Express Version Setup.exe”** to start the installation.
- Follow the instructions of the installation program.

The installation of TECTITE Express is followed by the installation of the TEC PDF Writer necessary for providing a printable protocol of the measurement.

After installation TECTITE Express can be started by clicking the icon on the desktop.

Test File

In the download folder there are samples of building test files of measurements with BlowerDoor MiniFan (with DuctBlaster B) and with BlowerDoor Standard (with model 4 fan); each with the file extension **.bld**. Open this file in the TECTITE Express and work on it. It is not necessary to set up or connect the measuring equipment to work in the file.

Additional information on the use of the program can be found in Chap. 5.

2.3 Installing the Pressure Gauge DG-1000

There are different options for connecting your DG-1000 gauge to your laptop computer to create the two-way communication link needed for automated testing with TECTITE Express:

- Connection with a USB data cable using the USB-C interface of the DG-1000 (→ Chap. 2.3.1)
- Wireless connection between gauge and laptop computer using the build-in WiFi module of DG-1000 (creating and broadcasting a Wireless Network) or by joining an existing WLAN network (→ Chap. 2.3.2).
- Connection with Ethernet cable and a router. The router must be running DHCP Server. A standard Ethernet switch can also be used, as long as it is connected to a device running a DHCP server (→ Chap. 2.3.3).



Note: You should first install the DG-1000 via the USB-C interface (→ Chap. 2.3.1). If desired, you can then install one of the other connections. Following each installation check whether TECTITE Express recognizes the DG-1000 (→ Chap. 2.3.4).



Fig. 2.1: DG-1000 ports

DG-1000 communication options

The communication ports are used to create a link between the DG-1000 and the computer.

The **build-in WiFi module** of the DG-1000 can be configured to broadcast a wireless local area network to which a computer or mobile device can connect. The WiFi module can also be configured to connect the DG-1000 to an existing wireless network.

The **USB-C port** on the DG-1000 can be used to create a communication link between the pressure gauge and a Windows computer using a USB data cable (USB 2.0 or above).

The **Ethernet port** on the gauge can be used to create a communication link with a router (the router must be running DHCP Server).

Note:

The **USB-A port** on the DG-1000 is not designed for digital communication to a computer, but for using accessories such as a keyboard.

Bluetooth communication is intended only for connection to the apps “TEC Gauge” and “TEC Auto Test” installed on Android or iOS devices, and not for measurements with TECTITE Express via a laptop.



For an overview of all DG-1000 connections please see → Chap. 3.2.1 (on page 31).

2.3.1 Installing the DG-1000 using USB-C port

Use of the USB-C port requires you to first download from the Internet and install the appropriate USB Device Driver to the computer.

Required for installation:

- DG-1000
- USB data cable (rated for USB 2.0 or above)
- Laptop/computer with internet connection

Installing the USB device driver:

- Make sure the computer is connected to the internet.
- Windows Update on the computer must be configured to allow downloading and installation of driver software.



Fig. 2.2

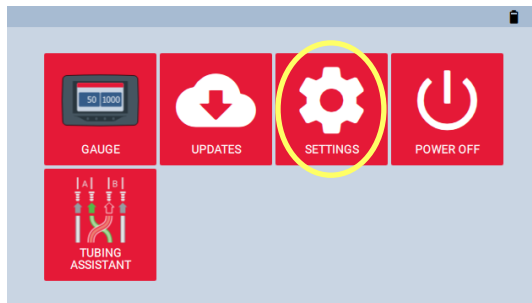

Fig. 2.3

- Turn on the DG-1000 pressure gauge by pressing and holding the power button for approx. 3 seconds until the green power indicator light turns on, and wait until the DG-1000 is booted. The bootup process may take some seconds to complete, and the gauge is ready to be used when the home screen appears (shown below).
- To enable the USB-C port on the DG-1000 gauge touch “Settings” on the home screen.

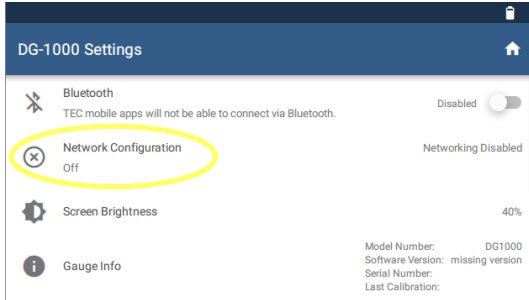

Fig. 2.4

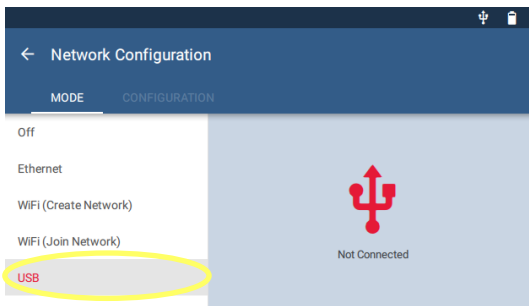

Fig. 2.5



Fig. 2.6

- Select “Network Configuration”.

- Select “USB C”.

The networking status in the Network Configuration screen will show “Not Connected”.

- Connect the DG-1000 to your laptop via the USB-C interface using a USB data cable (USB 2.0 or higher).

The appropriate device driver software is searched for on the Internet and installed.

Note:

With the USB data cable plugged into the gauge and the computer, open the Device Manager on the computer and look at the network adapters section. You should see an USB Remote NDIS network device in the network adapters section..

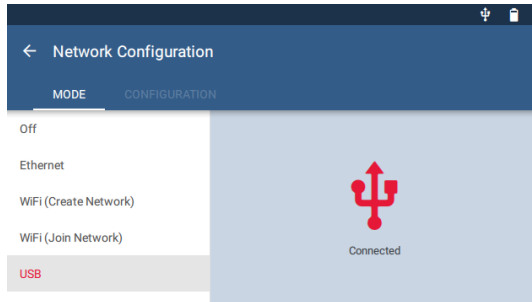

Fig. 2.7

TEC software installed on the laptop computer will now be able to detect the DG-1000 and create a communication link.

- Once the driver is installed, the networking status in the Network Configuration screen of the gauge will update to say “Connected.”

2.3.2 Wireless connection of the DG-1000 (WiFi)

The DG-1000’s built-in WiFi module can be configured to create and broadcast a wireless network that can be connected to directly from a computer or mobile device (→ Chap. 2.3.2.1). The DG-1000 can join an existing wireless network (→ Chap. 2.3.2.2).

2.3.2.1 Connection via the built-in WiFi module



Fig. 2.8

- Turn on the DG-1000 pressure gauge by pressing and holding the power button for approx. 3 seconds until the green power indicator light turns on, and wait until the DG-1000 is booted. The bootup process may take some seconds to complete, and the gauge is ready to be used when the home screen appears (shown below).

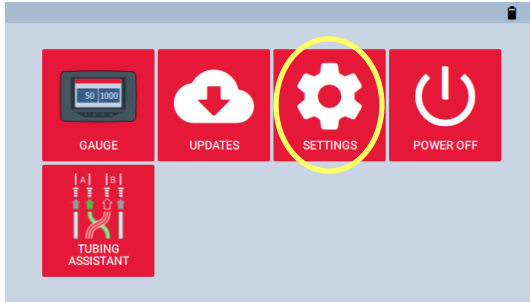

Fig. 2.9

- To enable WiFi (Create Network) touch “Settings” on the home screen.

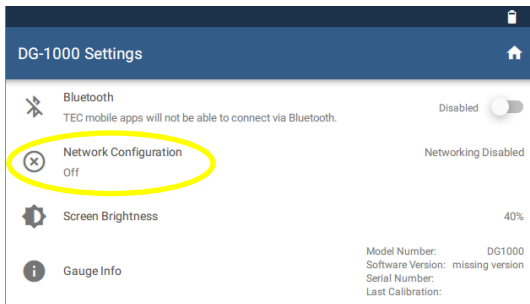

Fig. 2.10

- Select “Network Configuration”.

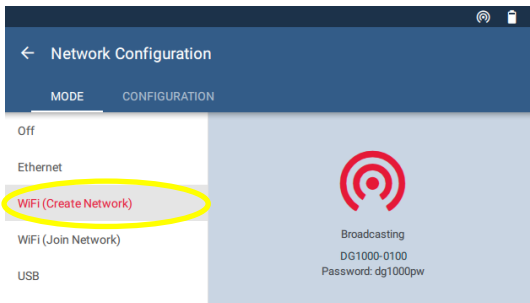

Fig. 2.11

- Select “WiFi (Create Network)”.
- The DG-1000 will begin broadcasting a secured wireless network with the following settings
SSID: DG1000-(serial number of gauge)
Password: dg1000pw



Fig. 2.12

- Select and connect to the DG-1000's wireless network on a computer or mobile device.

To connect to this network, you will be asked for a password. The default password is: **dg1000pw**.

Note:

If your laptop is already connected to another wireless network, you must disconnect from this network before establishing the connection to the DG-1000's wireless network. The DG-1000 must be on, in order for the WiFi network to be visible on your laptop.

TEC software installed on the computer or mobile device should now be able to detect the gauge and create a communication link.



The DG-1000's wireless network simply connects the pressure gauge to the computer or mobile device. **There is no connection to the Internet.** Occasionally this will be displayed on the computer or mobile device.

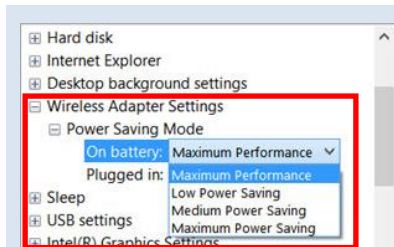

Fig. 2.13



For strong wireless connection we recommend to switch the **Wireless Adapter Settings** for battery and cable connection on „Maximum Performance“.

If interference on the WiFi Channel is suspected, follow these steps to broadcast on a different AP Channel at DG-1000:

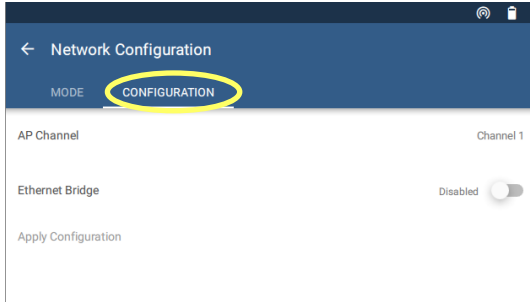

Fig. 2.14

- Select “WiFi (Create Network)” from the Network Configuration options.
- Then select “Configuration”.

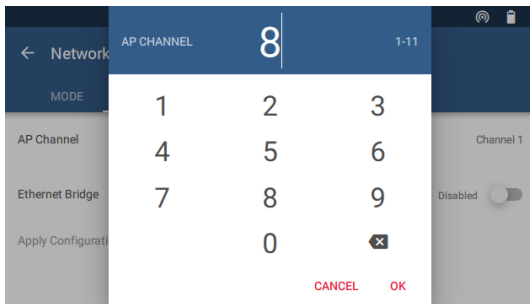
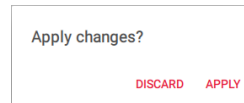

Fig. 2.15

- Touch AP Channel and enter in a different number between 1 and 11. Confirm with “OK” and then apply the configuration.



2.3.2.2 Connection to an existing WiFi network

The DG-1000 can join a wireless network using one of these methods.

- The DG-1000 can search for nearby wireless networks and populate a list so one can be selected and joined.
- A wireless network name (SSID) can be manually typed in, searched for and then joined.



Fig. 2.16

- Turn on the DG-1000 pressure gauge by pressing and holding the power button for approx. 3 seconds until the green power indicator light turns on, and wait until the DG-1000 is booted. The bootup process may take some seconds to complete, and the gauge is ready to be used when the home screen appears (shown below).

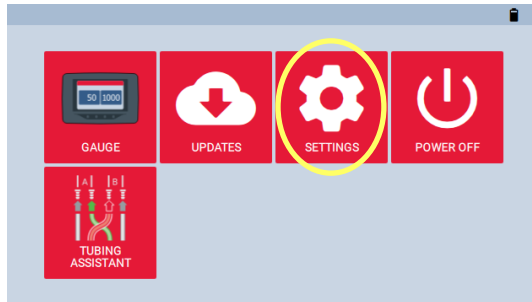

Fig. 2.17

- To enable WiFi (Join Network) touch “Settings” on the home screen.

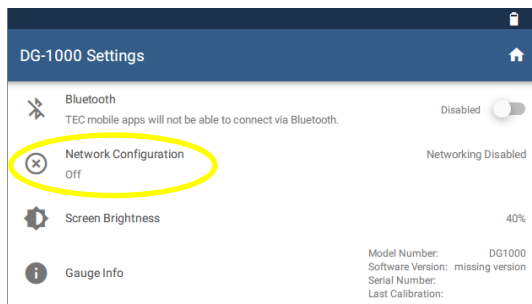

Fig. 2.18

- Select “Network Configuration”.

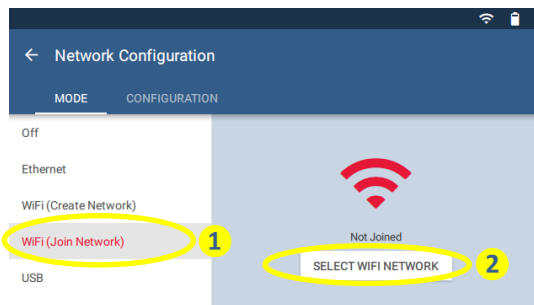

Fig. 2.19

- Select “WiFi (Join Network)”. Then touch “Select WiFi Network”. The DG-1000 starts searching for networks.

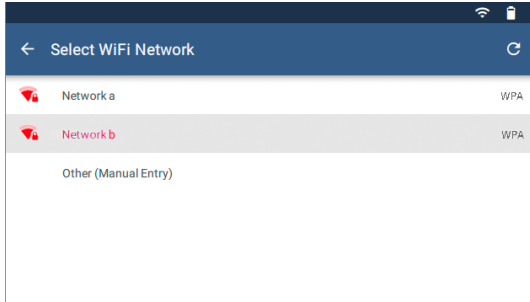

Fig. 2.20

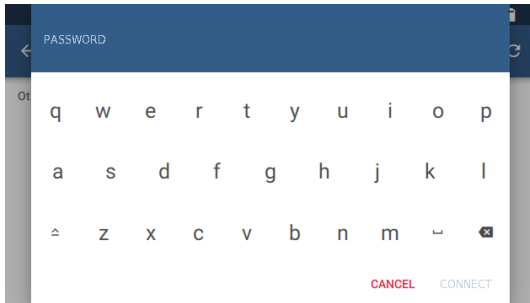

Fig. 2.21



Fig. 2.22

- Select which WiFi network the DG-1000 should connect to from the populated list.

- A pop-up window will appear asking for the password. Use the keypad provided to enter the password.

Then touch “Connect”.

Notes:

Should the password require a character that is not part of the keyboard on the gauge, connect a keyboard using the USB port on the gauge and enter the info using the external keyboard.



The DG-1000 does not have an option for entering a username, so WiFi networks that require a username can't be connected to by the DG-1000.



Fig. 2.23

Older software versions may need to manually enter the WiFi network SSID. To do this, touch “WiFi (Join Network)”, then “Configure”, and provide the required information.

The status on the Mode screen will say “Joined” if the DG-1000 was able to connect.

Once the DG-1000 joins a wireless network, the gauge can be accessed using TEC software, if the computer or mobile device running the software is also connected to the same network.

2.3.3 Installing the DG-1000 using Ethernet port

The Ethernet port on the DG-1000 is used, among other options, when controlling multiple fans with multiple DG-1000 (BlowerDoor MultipleFan) and to allow larger distances between the measuring device and the computer. The communication is then made through a router, or a switch connected to a router; the router must run DHCP server.



Required for installation:

- DG-1000
- Ethernet cable (Network cable, stranded CAT5 cable)
- **Router running DHCP Server!**

Installation steps:



Fig. 2.24

- Turn on the DG-1000 pressure gauge by pressing and holding the power button for approx. 3 seconds until the green power indicator light turns on, and wait until the DG-1000 is booted.

The bootup process may take some seconds to complete, and the gauge is ready to be used when the home screen appears (shown below).

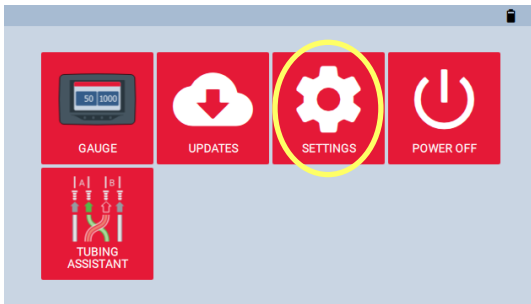

Fig. 2.25

- To enable Ethernet connection touch “Settings” on the home screen.

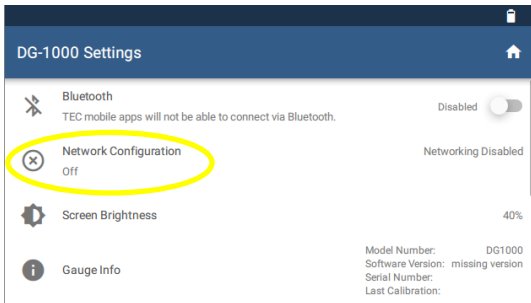

Fig. 2.26

- Select “Network Configuration”.

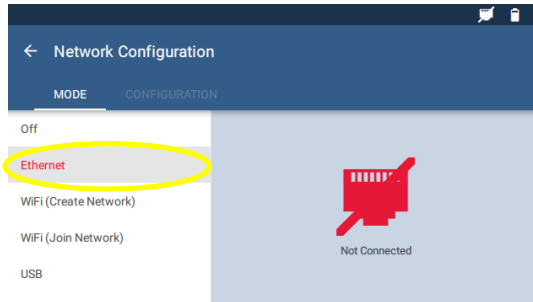

Fig. 2.27

- Select “Ethernet”.
Ethernet will initially displays “Not Connected” on the right half of the screen.



Fig. 2.28

- Plug in an Ethernet cable into the DG-1000’s Ethernet port and into the Ethernet port on a router (in Fig. 2.28: red cable).

The Network Configuration status should update to show “Connected”.

If the status continues to show “Not Connected” after two minutes, make sure the cables have been installed correctly and that the router is powered and running DHCP Server.

- Connect the computer to the same router, using either an additional Ethernet cable, or through a wireless connection.

Once this connection is made, TEC software installed on the computer should be able to detect the DG-1000 and create a communication link. Ethernet cables can be up to 100 meters long and still provide a robust communication link.

2.3.4 Testing whether TECTITE Express recognizes the DG-1000

Automated testing, semi-automated testing or cruising cannot begin until the necessary communication link between your laptop and DG-1000 has been established. Directly following the installation, it is thus recommended to check whether the DG-1000 is recognized by your laptop.

- Turn on your DG-1000 and connect to laptop computer (→ Chap. 2.3.1 to Chap. 2.3.3.)
- Start the TECTITE Express software for your check.

Alternative 1:

Go to the **File** menu and open a **New Measurement**. Continue to click to the window **Test Graph (Auto Method)**. TECTITE Express will automatically begin to scan for a pressure gauge.

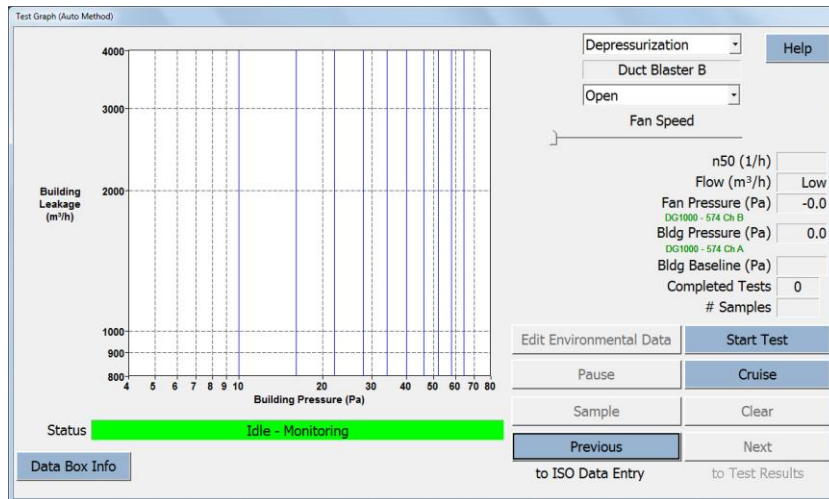

Fig. 2.29

A green status bar indicates that the DG-1000 has been installed correctly and is recognized by TECTITE Express. **DG-1000 is now fully remote controlled by TECTITE Express.**

Alternative 2:

In the **Options** menu, select **Device Connection**.

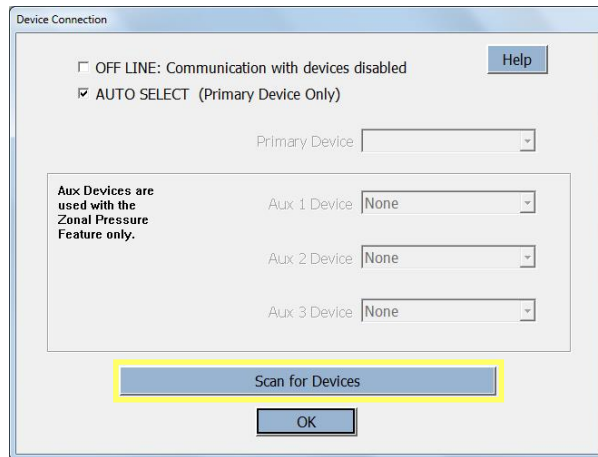

Fig. 2.30

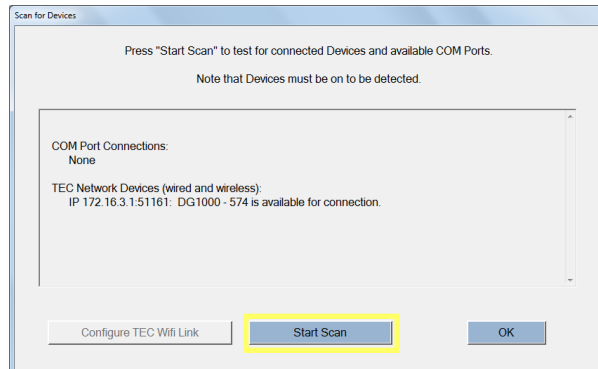

Fig. 2.31

The window will open set to **AUTO SELECT**:

To check your computer for all currently installed connected BlowerDoor devices and available COM ports click on the **Scan for Devices** button.

Once the Scan window is open, clicking on **Start Scan** will provide a list of all installed communication ports on your computer. The scan will also show all BlowerDoor Devices that are connected to the listed communication ports.



In addition, if you are using DG-1000's built-in WiFi module and your laptop is connected to the WiFi network, the scan will show all the device connected through this wireless network.



Wireless communication is only enabled when *AUTO SELECT* is checked.

Information:

- The Primary Device is the DG-1000 that will be used to measure building pressure and fan flow during the Blower Door test. The Primary COM Port is the communication port on your computer that will be used to communicate with the Primary Device.
- Checking the **AUTO SELECT** button in the **COM Port Selection** window will allow TECTITE Express to automatically search for BlowerDoor devices on all available communication ports on your computer. If you are unsure which COM Port to use, check the **AUTO SELECT** button. **AUTO SELECT** will attempt to establish a communication link with the first device that it finds. If a communication link is established, this device is considered the Primary Device.
- If you uncheck **AUTO SELECT**, you may specify a Primary COM Port (COM 1 through COM 256). This is only possible with a cable connection!

3 Components of BlowerDoor MiniFan Measurement System



Fig. 3.1

Portable BlowerDoor equipment

consisting of the adjustable mounting frame in its grey transport bag as well as the black accessories bag containing the measuring fan DuctBlaster B, the fan speed controller, the fan cap, the red BlowerDoor panel, the pressure gauge DG-1000 in its transport bag, tubing, the reference guide, the calibration certificates and if chosen a leak detection device.

3.1 Measuring fan and speed controller



Fig. 3.2

BlowerDoor fan, flow rings 1-4 and fan cap

The flow rings are fixed so that the labeling is facing out (legibly). Only one flow ring at a time is attached.

The measuring fan and the rings are labeled with the device serial number DB-CE XXXX. The calibration of the rings is only valid together with the corresponding fan.



BlowerDoor speed controller

The speed controller is mounted on the gauge board.

Fig. 3.3: Fan speed controller for DuctBlaster B fan

3.2 DG-1000



Pressure gauge DG 1000

for automatic, semi-automatic and manual BlowerDoor measurement in padded bag with

- two lithium-ion batteries (installed)
- charger
- USB data cable
- fan control cable
- calibration certificate
- tube connectors, WindTee and others

Fig. 3.4: DG-1000

DG-1000 display is available in the following languages: English, German, Spanish, French, Italian, Norwegian, Dutch, Portuguese, Chinese.

3.2.1 Overview of the DG-1000

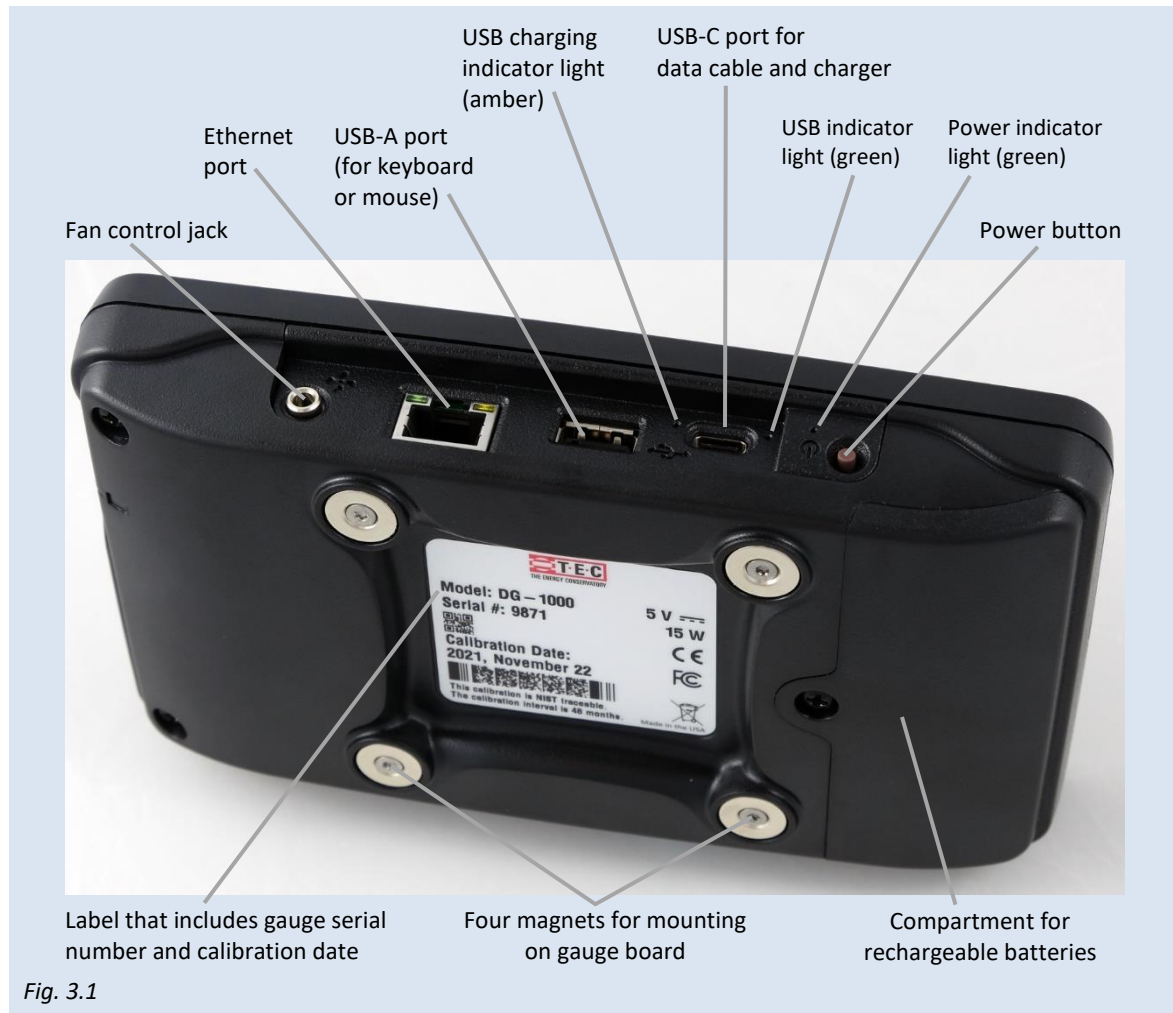

Fig. 3.1

3.2.2 Applications

The DG-1000 is a digital pressure gauge with two channels for measuring pressure differentials. The DG-1000 can be used for airtightness testing in the following ways:

- If connected to a laptop, the DG-1000 automatically controls the fan. You can maintain a

constant building pressure for leakage detection, and you can also conduct an automated (as well as semi-automated) series of measurements to determine air flow at negative and positive pressures.

- The DG-1000 can control the fan to maintain a building pressure (cruise feature) without being connected to a computer. In addition to custom defined pressure differences, pressure difference of 50 Pa (for leakage detection), 25 Pa, 75 Pa, 0 Pa and +0 Pa are preset.
- You can also conduct manual measurements and read the pressure differentials from the gauge's display.

The gauge regularly zeroes out the sensors (you will hear a clicking noise).



Do not move the DG-1000 during the test.

3.3 Mounting frame and panel



Fig. 3.5

BlowerDoor adjustable mounting frame

Four external braces for mounting frame:

Two vertical braces for the sides (long) and two horizontal braces for the top and bottom (short).

Two internal cross bars – one with Velcro to support the fan.



Fig. 3.6: Ends of the external braces of frame



Fig. 3.7: Ends of the internal cross bars

4 Installing the BlowerDoor MiniFan System



Fig. 4.1

The BlowerDoor system is typically controlled from inside the building. All BlowerDoor equipment (bags, frames, fans, computer, paperwork, cable drum, etc.) is placed in the selected room of the building to be measured.

A power supply of 220-240 V is required (electrical outlet or power cable from cable drum to worksite power distribution).

The BlowerDoor measurement system is installed in the building envelope, usually in a French doorway on the lowest floor being tested. It is installed in this location instead of in the main doorway of the building so that the leakage of the main door is included in the airtightness test results.



Keep the inlet area of the fan free of all obstacles

For a controlled regulation, the inlet area of the BlowerDoor fan must be free of all obstacles.

The following distances to obstacles in front of and behind the fan must be observed: Make sure that there is a clearance from the intake of the fan of at least 1.5 m (with an open fan) or 2.5 times the orifice diameter of the ring used. The fan outlet must have a clearance of at least 1 m.

The greatest measuring accuracy is also achieved by maintaining a lateral distance of at least 30 cm with an open fan. When using one or more rings, there is no minimum lateral distance is required.

Experience has shown that the installation in the outer doorway of a large open area is a good option, so that air flowing into or out of the fan is not obstructed by obstacles (e.g., stairs). Do not install the fan in doors that open onto narrow hallways or if staircases or large obstacles obstruct the airflow.

If the fan must be installed next to a staircase or an other large obstacle, use a flow ring, at least ring A and avoid measurement with open fan.

Open the door in which the fan is installed as far as possible to avoid obstructing the air flow.

To prepare the building, close all external doors and windows, open all internal doors, and apply temporary seals if necessary.

4.1 Installing the tubing for measuring outside pressure



The transparent 10 m long tubing is used when measuring the outside pressure (reference measuring point) for the building pressure differentials. One end is connected from the outside onto the green marked connector of the nylon panel, the other end of tubing is placed at a **distance of about 10 m from the building** and fitted with a tube connector T (T-piece).



Be sure the outside end of the tubing does not be in the outlet area or in the exhaust flow of the measuring fan, as turbulence will occur there. In windy conditions, the end of the tubing is placed as far away as possible from the building or obstacles in order to measure the outside pressure in an undisturbed area. It is useful to lay the tube on the downwind side (lee side) of the building. When exposed to sunlight, lay the tube horizontally to prevent thermal flow in the tube.

The WindTee (→ see lower photo) can be used as an alternative to the tube connector T (→ photo above). It provides the same readings and also protects the tube against direct inflow of air due to wind. Due to the larger diameter, it also prevents from moisture intrusion due to its larger diameter for example in the event of rain.

Fig. 4.2

4.2 Installing the mounting frame and panel

The mounting frame and panel are installed from inside the building.

The four external braces of mounting frame are laid on the ground so that they form a rectangle (→ Fig. 4.6). The clamping levers and adjustment knobs should all be on the same side of the frame. The opposite ends of the frame should be identical (either with two clamping levers and adjustment knobs in the corner, or without the levers and knobs).

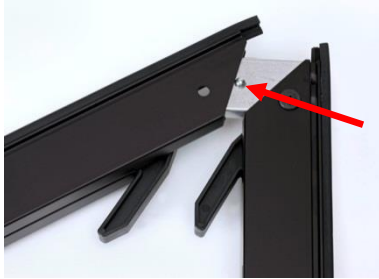

Fig. 4.3

The four external braces are joined with button catches (push down on the button, connect the bars, and release the button so that it locks into position).

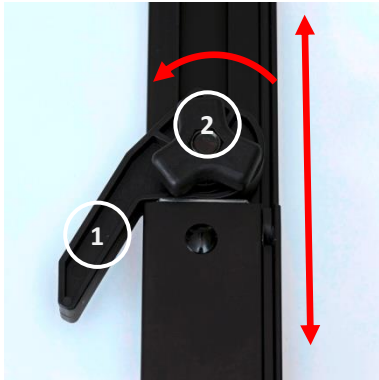



Fig. 4.4

 The clamping levers (1) must be open before the adjustment knobs (2) are used.

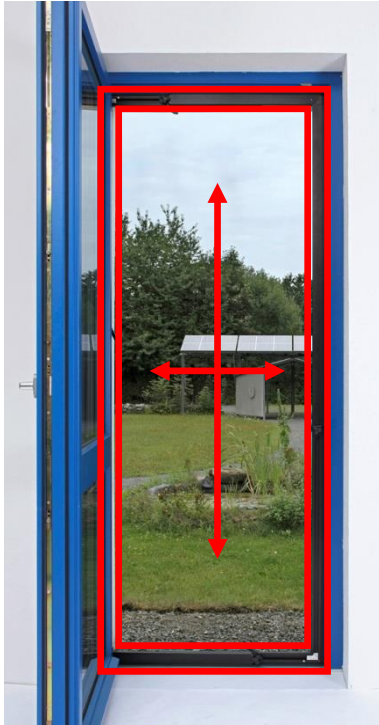

Fig. 4.5

Once the four external braces have been assembled, adjust the frame to loosely fit the dimensions of the door frame (leave about a finger's width on all sides).

Slide the frame into the door opening.

Re-adjust the frame height and width to the door opening by loosening the knobs on the braces and extending the frame pieces. After the braces have been adjusted, retighten the knobs.

To leave enough space for installing the panel, do not fully adjust the frame to the door opening. Leave about one finger's width of space.



Fig. 4.6

Unfold the BlowerDoor panel on the floor and place the assembled frame on top (with the clamping levers pointing up). The Velcro straps on the panel should also face up.

Loosely fold the panel around the frame and secure it with the Velcro straps.



Fig. 4.7

Before installing the fan into the panel opening, attach the long transparent tubing to the outside of the green connector at the bottom of the panel.

When installing the frame, make sure that the tube is not jammed between the frame of the door and the BlowerDoor frame.



Fig. 4.8

You are now ready to fit the frame and panel into the doorway. Place one foot on the bottom horizontal brace of mounting frame and one hand against the top brace. Loosen the adjustment knob of one of the vertical braces. Slide the braces apart and press them firmly into the door opening. Once the height is fixed, retighten the adjustment knob on the vertical brace. Repeat on the other side.

To adjust the frame width, use the same method on the top and bottom horizontal braces.

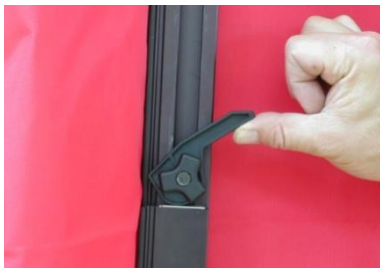

Fig. 4.9

Finally, engage all four clamping levers. This tightly secures the frame in the doorway.



Fig. 4.10

To further stabilize the frame, install the two cross bars. The middle cross bar with the Velcro strap goes directly above the fan opening in the panel; the fan will later attach to this. Place the second cross bar wherever it will best stabilize the frame.

To install the cross bars, release the adjustment knobs on the bars, slide the cross bar halves apart, insert the ends of the cross bars into the slots on the vertical frame braces, tighten the adjustment knobs and engage the clamping levers to tighten the frame.



Fig. 4.11

You can test the stability of the frame by pulling on the cross bars. If the frame moves, tighten it further.

If the power supply is located outside of the building, run the power cable from the cable reel through the fan opening in the panel.

4.3 Installing the BlowerDoor fan, flow rings, and speed controller



Fig. 4.12

For a negative pressure test, fit the fan into the elastic collar in the panel so that the flow rings are facing into the room. The elastic collar should fit snugly around the fan.

Begin the test e.g. with flow ring 1 installed.

TECTITE Express will indicate a change of flow rings if necessary.



Fig. 4.13

The Velcro strap on the cross bar directly above the opening in the panel holds the fan in place. Pull the strap through the handle on the fan and secure it.

4.3.1 Changing the flow rings

Each flow ring has an ideal measurement range (→ Appendix B.2).

i **Note:** When **automatically recording a series of measurements** with TECTITE Express, the software will indicate a change of flow rings.

If the **aperture of the flow ring** chosen during leakage detection is **too big**, you will reach a building pressure of, for example, 50 Pa, but will remain below the measuring range for this ring. The building envelope is more airtight than expected and you will have to insert a smaller ring.

If the **aperture of the flow ring** chosen is **too small**, you will not even reach the desired building pressure differential of, for example, 50 Pa at full fan speed. In this case, the building envelope is less airtight than expected and you will have to continue the measurement with the next biggest ring size.

4.3.2 View of open fan



Fig. 4.14

The flow rings are fixed to the fan with the flexible connecting trim enclosed. It clasps all the way around the fan flange as well as the outer edge of the flow ring. The labeling must be legible and facing out.



Fig. 4.15

When using rings, the labeling must point readable outward.

Only one flow ring at a time is attached. In order to attach another flow ring to the measuring fan, you will have to remove any previously installed flow ring.

4.3.3 View of fan with flow rings 1, 2, 3, and 4



Fig. 4.16: Fan with ring 1, ring 2, ring 3 and ring 4.

i When using ring 1, 2 or 3 the aperture bends inwards/toward the fan. The center of ring 4 is vaulted outwards. For determining the airflow of the fan when using flow ring 4, the red tubing should be connected to ring 4.



Fig. 4.17

Putting on the fan cover

Seal off the fan by installing the nylon fan cover over the fan. The fan is sealed in order to measure the building baseline pressure during the airtightness test.



Fig. 4.18

Hang the fan speed controller and the DG-1000 on the upper of the two cross bars using the clamp on the back of the gauge board. Before connecting the speed controller to the fan, make sure the switch on the controller is set to “off” and that the control knob is turned completely to minimum.

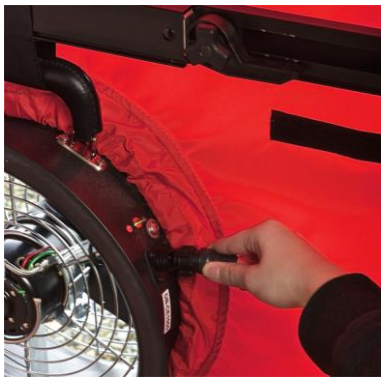
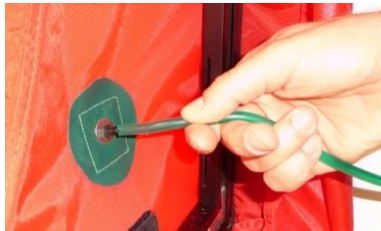

Fig. 4.19

Next, the fan speed controller is connected to the fan and to the power supply.

4.4 Connecting tubing to BlowerDoor panel and measuring fan



Connect one end of the green tubing to the connector at the bottom right corner of the panel. Outside the building, the transparent tubing should have been connected to the same connector.

For connecting the tubing to the pressure gauge → chap. 4.5.4

Fig. 4.20

4.4.1 Depressurization measurement

To determine the air flow during the **depressurization measurement**, connect the red tube to the connector at the fan marked in red (open fan or when using ring 1 to 3).

The blue tube is laid near the fan intake. It is recommended to lead it through the Velcro fastening at the lower cross bar of the frame.



Fig. 4.21

4.4.2 Pressurization measurement

To determine the air flow during the **pressurization measurement**, the fan is turned around, the fan inlet opening (side of flow rings) points outwards.

Then connect the red tube to the connector at the fan marked in red (open fan or when using ring 1 to 3). The blue tube is connected to the connector at the panel marked in blue.



Fig. 4.22

4.4.3 Depressurization and pressurization measurement with ring 4

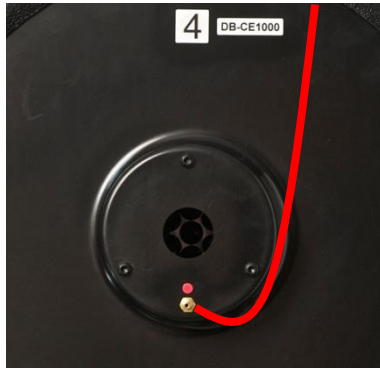

Fig. 4.23

When using ring 4 for determining the airflow at the fan (depressurization measurements and pressurization measurements), connect the red tubing to the port on ring 4.

4.5 Connecting the Pressure Gauge DG-1000

4.5.1 Power supply for the DG-1000

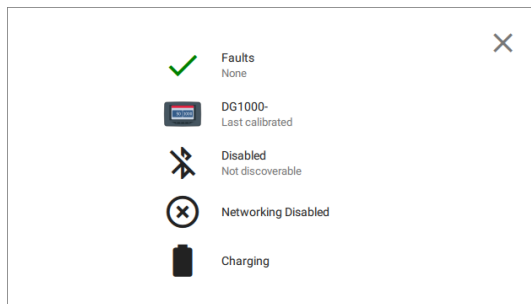

Fig. 4.24

The DG-1000 uses two lithium-ion batteries that are rechargeable and replaceable. The battery compartment is located on the back of the gauge.

To view the current battery level, turn on and boot up the DG-1000 and touch the battery icon. A pop-up will appear at the bottom of the screen indicating the battery level.

For details → [Appendix B.1](#).

4.5.2 Connecting the DG-1000 to the fan speed controller



Fig. 4.25

The DG-1000 is mounted on the gauge board using the four magnets on its backside. Connect the gauge to the fan speed controller with the fan control cable (the cable with a 3.5 mm jack at each end).



Fig. 4.26

Note:

Before storing the pressure gauge in its pocket, remove all connected cables.

4.5.3 Connecting the DG-1000 to a laptop

In order to conduct automated measurements with a laptop and TECTITE Express, connect the DG-1000 to the laptop (→ see also Section 2.3) and to the fan speed controller.



Fig. 4.27

Communication interfaces of DG-1000

- Build-in WiFi module
- USB-C port (left marking) for USB data cable
- Ethernet port (middle) for connection to a router
- Fan control jack for linking fan control cable to speed controller

Note:

If TECTITE Express does not recognize the DG-1000 → Chap. 2.3.4.

4.5.4 Connecting the tubing to the DG-1000



Fig. 4.28: Tube connection at DG-1000

Channel A: Building Pressure Differential

INPUT: **open** (building pressure)

REF: **green** tubing (outside pressure)

Channel B: Fan Pressure Differential (flow)

INPUT: **red** tubing (fan pressure)

REF: **blue** tubing (fan reference pressure)



Fig. 4.29

If there is air turbulence near the gauge, perhaps due to location (e.g. a narrow hallway), slip an additional piece of tubing over Channel A (input). Face the open end of this tubing away from the air turbulence.

Note:

DG-1000 has a tubing assistant app for various measuring tasks. To do this, open the tubing assistant via the start screen.

4.6 Overview of the Negative Pressure Test and Positive Pressure Test

4.6.1 Overview of the negative pressure test / depressurization measurement

The fan inlet opening (side of flow rings) points inward, and air is sucked out of the building.

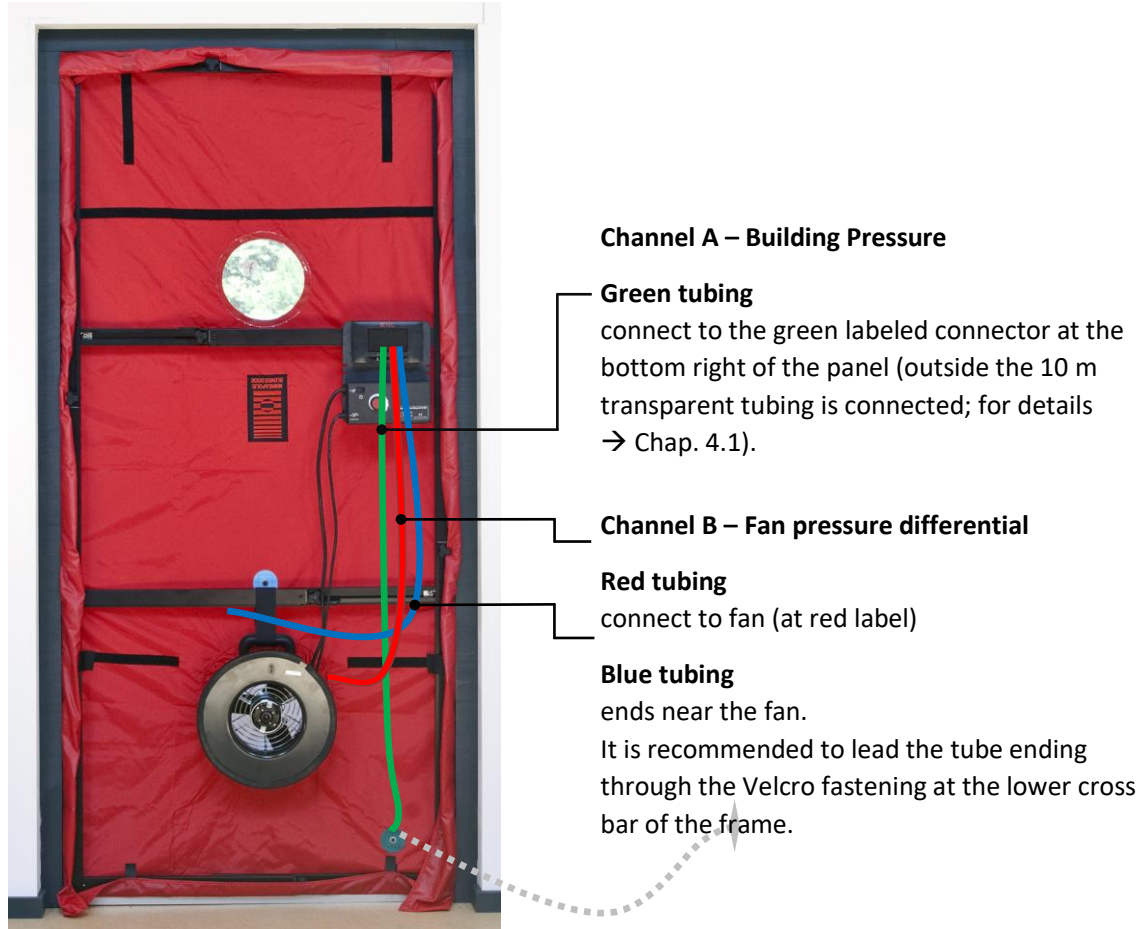

Fig. 4.30



If flow ring 4 is used, the red tubing should be connected to ring 4 instead of to the fan.

4.6.2 Overview of the positive pressure test / pressurization measurement



Fig. 4.31

For a **positive pressure test**, the fan is **turned around**. The fan inlet opening (side of flow rings) points outwards, and air is sucked into the building.

The connection of the red tube remains unchanged. The blue tube is connected to the connection on the inner side of the panel marked in blue.



Fig. 4.1

On the outer side of the panel, you attach a transparent piece of tubing of approximately 5 cm in length plus a tube connector T.



Optional:

If you encounter strong pressure fluctuations while recording the pressurization series, connect another transparent tube to the free connection of Channel A on the DG-1000 and place the end of the tube into a flow-reduced area.



If flow ring 4 is used, the red tubing should be connected to ring 4 instead of to the fan.

5 Computer-Controlled Tests with TECTITE Express

Verification of airtightness layer is carried out with software TECTITE Express in accordance with the European measurement standards of EN 13829 or EN ISO 9972:2015. TECTITE Express makes data entry easy and allows you to take one-point measurements.



Fig. 5.1

TECTITE Express offers detailed help for all windows (i.e. warning message windows). The *Help* button always appears in the upper right of the window. Familiarity with the European standards ISO 9972 and/or EN 13829 is helpful!

The main window of TECTITE Express is explained in detail below:



TECTITE Express 5.1

Fig. 5.2

Opening TECTITE Express

Once the program has been installed, click the TECTITE Express icon on the desktop to open.



Fig. 5.3

TECTITE Express start-up screen

After clicking the icon, the start-up screen appears.

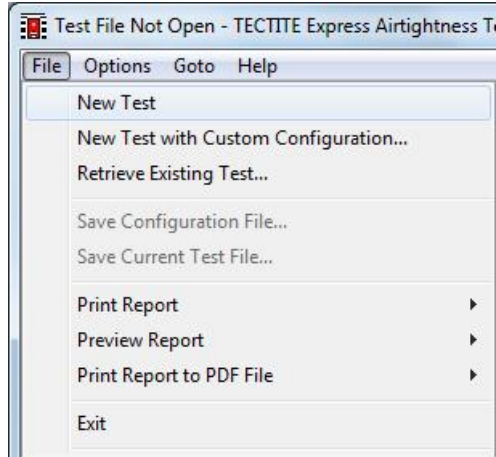

Fig. 5.4

Opening a new measurement file

To begin a new measurement select the item **File/New Test** in the menu bar.

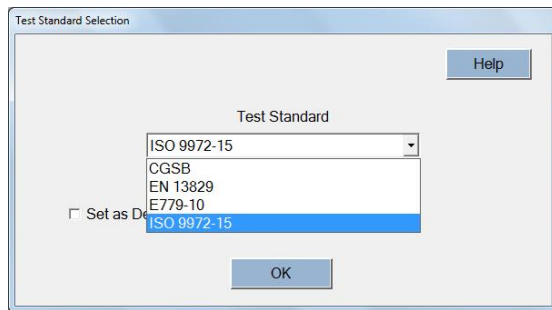

Fig. 5.5



Test Standard Selection

Use this window to select the Measuring Standard EN ISO 9972 or EN 13829. The ISO is preselected.

Check marking the box **Set as Defaults for New Tests** will save the selected Test Standard so that it will be applied to all future new tests.

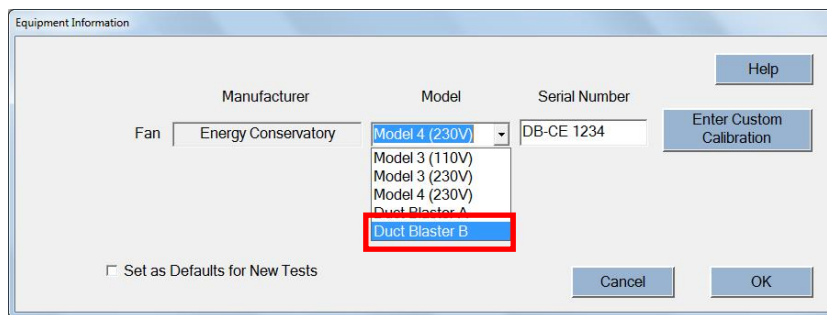

Fig. 5.6

Equipment Information

Use this window to select the fan model DuctBlaster B and enter its serial number.

Fig. 5.7

Building test information window

Enter all data relevant to the test in this window: dates, tester, client, building address and building data.

Fig. 5.8

Comments window

This window is for additional notes such as placement of the BlowerDoor Measurement System, temporary seals, building condition at the time of the test, and large leaks.

Fig. 5.9

**Note:**

An increase in the **Samples per station** (measuring points per pressure differential) to, for example, 300 will improve accuracy since more values are used to determine the mean value. This is especially useful when it is windy. (For further information to semi-automated measurement, → see also Chap. 5.2.2.)

Test settings window

Use this window to change the pre-set measurement series and other test settings as well as to change the selected measuring standards if necessary.

Fig. 5.10

ISO 9972 data entry window

Enter all data pertaining to the measurement standards.

For data entry in accordance with EN 13829, → Fig. 5.11.

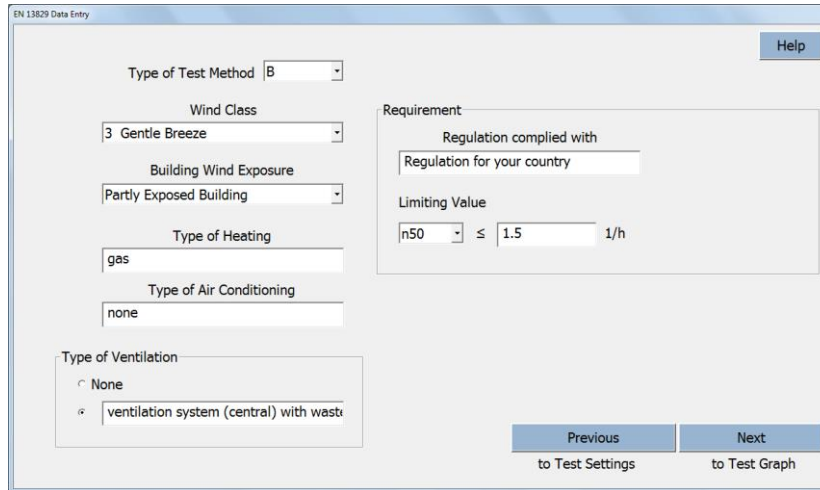

Fig. 5.11

EN 13829 data entry window

Enter all data pertaining to the measurement standards.

For data entry in accordance with ISO 9972, → Fig. 5.10.

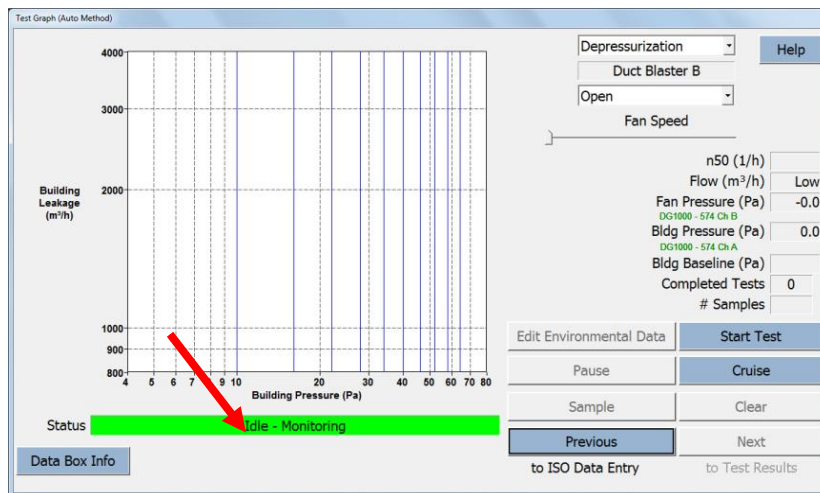

Fig. 5.12

Test graph window (measurement and leakage curve)

This window controls the automated measurement including the method of testing (positive or negative pressure).

A green status bar indicates that the DG-1000 has been installed correctly and is recognized by TECTITE Express. **DG-1000 is now fully remote controlled by TECTITE Express.**

If the status bar is grey, check if the gauge is switched on, if the cables are connected correctly, or if the WiFi-connection has been established. Make sure that the **Bluetooth function of the computer is turned off.**



Before beginning the automated test, make sure that the speed controller is on and that the knob is set to minimum.

In order to create a test report that meets the standards, first check the building for leaks at a constant negative pressure of 50 Pa (→ Chap. 5.1). Then, take and record a series of measurements at both negative and positive pressure (→ Chap. 5.2).

5.1 Leakage Detection at Constant Negative Pressure with TECTITE Express

For an initial assessment of airtightness, and for locating leaks during a walk-through, generate a constant pressure differential (usually -50 Pa) in the building.

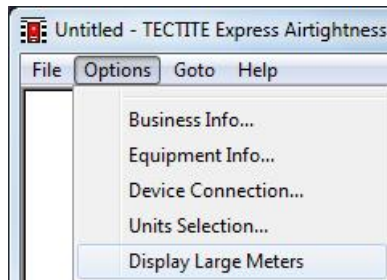

Displaying measurements

Under **Options**, select **Display Large Meters** to see a large display of real-time measurements that are being taken.

Fig. 5.13

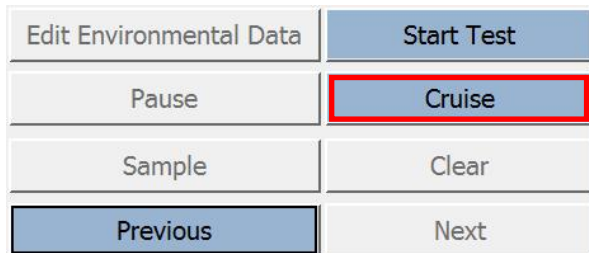

Fig. 5.14

Keeping the building pressure differential at 50 Pa

Hitting the **Cruise** button instructs TECTITE Express to run the BlowerDoor fan automatically at a constant pressure differential until the **Stop Cruise** button is hit.

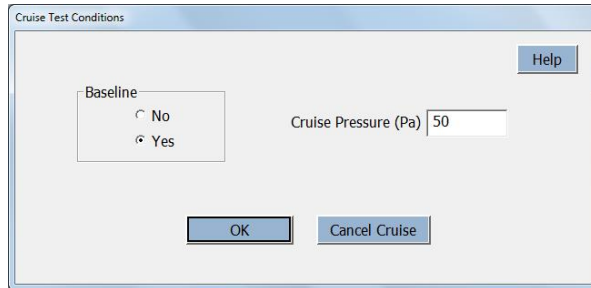

Fig. 5.15

Cruise Test Conditions

Prior to starting the Cruise Test, decide if it is necessary or not to set a **Baseline** and the building pressure by inserting the desired **Cruise Pressure** (50 Pa).

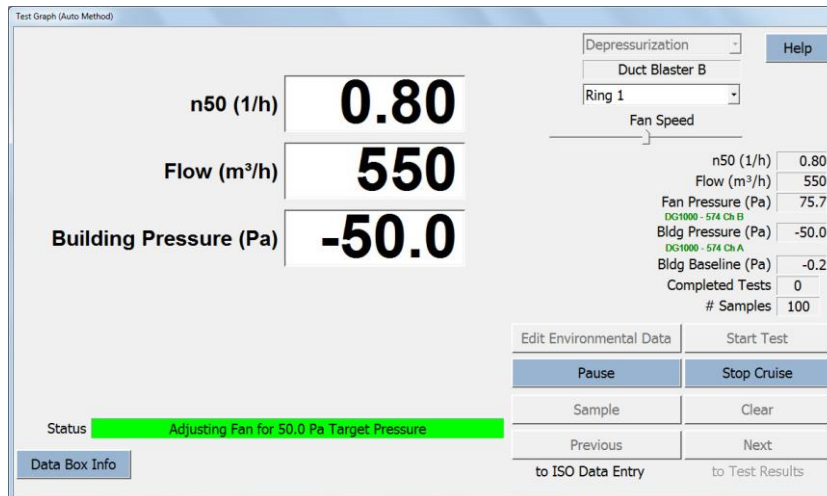

Fig. 5.16

Test graph window / Display Large Meters

Building pressure, current flow rate, and the estimated air change rate n_{50} at 50 Pa are shown in the large display window.

If the flow rate is not displayed, use a smaller flow ring. If the air change rate n_{50} is not displayed, the building volume has not been entered, or the building pressure is less than 40 Pa.

To deactivate the large display, deselect the menu item **Options/ Display Large Meters**.

5.2 Taking a Series of Measurements with TECTITE Express

5.2.1 Automated Measurement

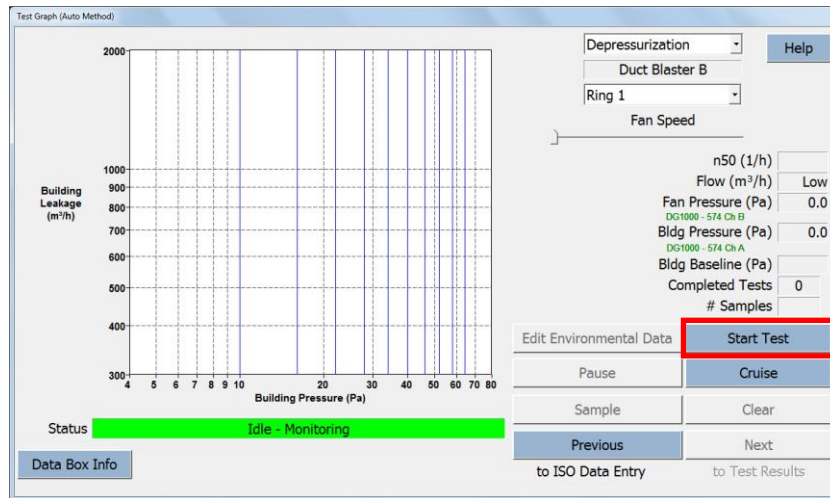

Test and leak graph window

Now start the automated test by hitting **Start Test**. The software will interactively guide you through the test procedure.

Fig. 5.17

The screenshot shows the 'ISO 9972 Temperature and Barometric Pressure Entry' dialog box. It has a title bar with a close button and a 'Help' button. The main text says 'Temperature and Barometric Pressure values must be entered.' Below this are two sections: 'Temperature' with 'Indoor Temperature (°C)' and 'Outdoor Temperature (°C)' input fields, and 'Barometric Pressure' with 'Standard' (set to 101325 Pa), 'Barometric Pressure' (input field), and 'Altitude' (input field) fields. At the bottom are 'OK' and 'Cancel Test' buttons.

Temperature and Barometric Pressure Entry

Temperature – indoor and outdoor – and barometric pressure values must be entered prior to starting the measurement.

After the measurement, this data can be changed in the Test Graph window by clicking on **Edit Environmental Data**.

Fig. 5.18

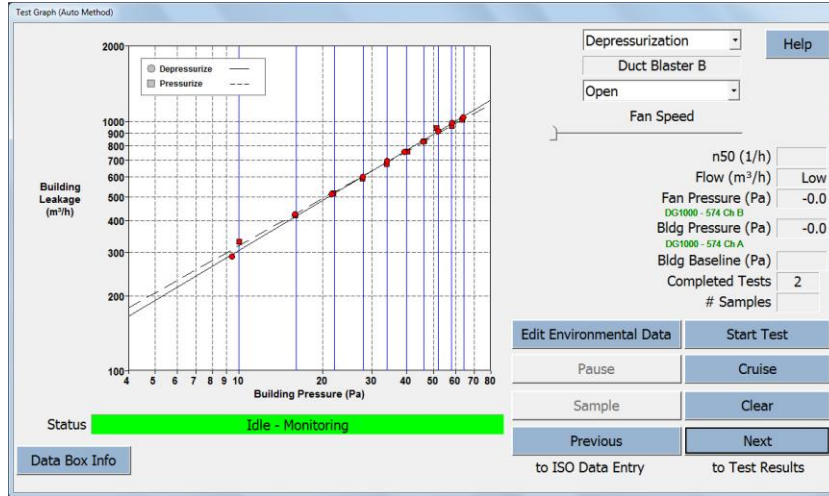

Display of a complete test at negative and positive pressure

Negative and positive pressure measurements can be taken directly after each other. TECTITE Express shows both curves in one diagram.

Fig. 5.19

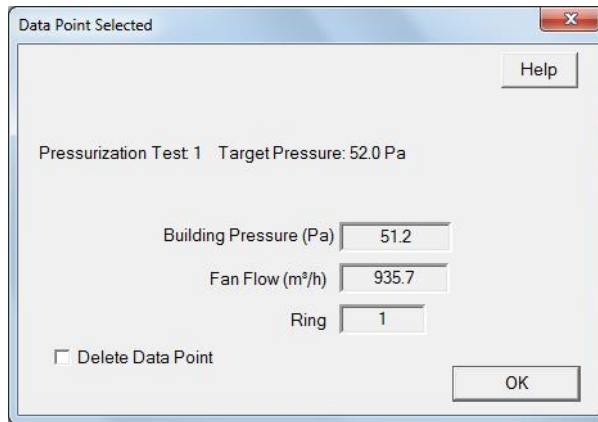

Data point selection and detection

Individual data points can be reviewed and permanently deleted from the graph.

By clicking in the **Test Graph** window on a data point will bring up a **Data Point Selected** window which lists the measured parameters for the data point, and includes a data point deletion option.

Fig. 5.20

	Depressurization	Pressurization	Average
Airflow at 50 Pascals			
q50 : m ³ /h	890 (+/- 1.1 %)	872 (+/- 2.4 %)	881
n50 : 1/h (Air Change Rate)	1.18	1.16	1.17
qF50 : m ³ /(h·m ² Floor Area)	7.01	6.87	6.94
qE50 : m ³ /(h·m ² Envelope Area)	2.32	2.27	2.29
Leakage Areas			
ELA50 : m ²	0.0271 (+/- 2.4 %)	0.0266 (+/- 2.4 %)	0.0269
ELAF50 : m ² /m ²	0.0002138	0.0002094	0.0002116
ELAE50 : m ² /m ²	0.0000707	0.0000692	0.0000699
Building Leakage Curve			
Air Flow Coefficient (C _{env}) m ³ /(h·Pa ⁿ)	66.2 (+/- 5.3 %)	75.1 (+/- 11.9 %)	
Air Leakage Coefficient (C _L) m ³ /(h·Pa ⁿ)	65.9 (+/- 5.3 %)	75.0 (+/- 11.9 %)	
Exponent (n)	0.665 (+/- 0.015)	0.627 (+/- 0.034)	
Coefficient of Determination (r ²)	0.99922	0.99563	

Fig. 5.21

Test results window

This window displays an overview of the test results.

The results are shown with the preset reference pressure of 50 Pa. If needed, the reference pressure can be changed (according to country-specific requirements).

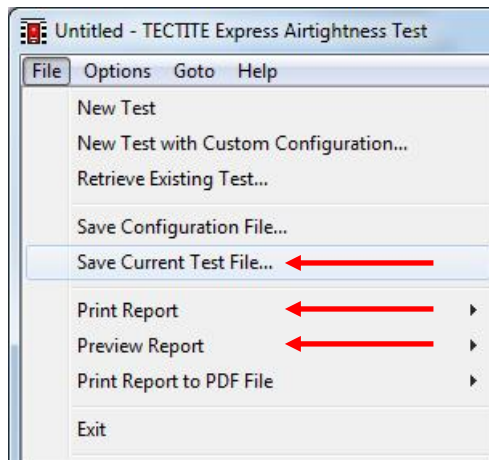

Fig. 5.22

Saving, viewing, and printing results

Under **File** you can

- Save the test current results
- Print the test report
- Preview the test report with all important data.

See → Chap. 6 for further indications.

5.2.2 Semi-automated Measurement

If you have

- a very airtight building,
- a test when there is a lot of wind,
- a test when a lot of vapor barriers (foils, etc.) are visible inside the building
- or a combination of the three points

the automated BlowerDoor Test in TECTITE Express maybe don't work proper. Then use the Semi-Automated Test.

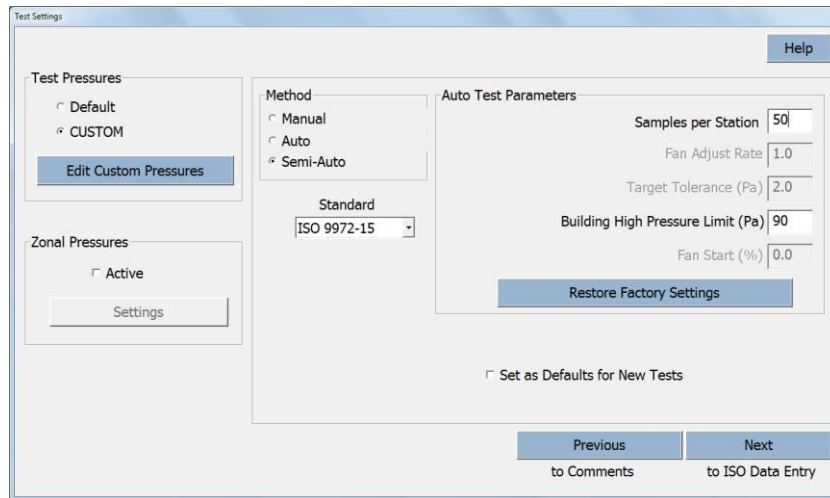

Fig. 5.23

Test settings window

Select **Semi-Auto** if you will use a DG-1000 for automated collection of test readings, but will be manually controlling the BlowerDoor fan.

In a semi-automated test, just **Samples per Station** and **Building High Pressure Limit (Pa)** can be adjusted from the Auto Test Parameters.

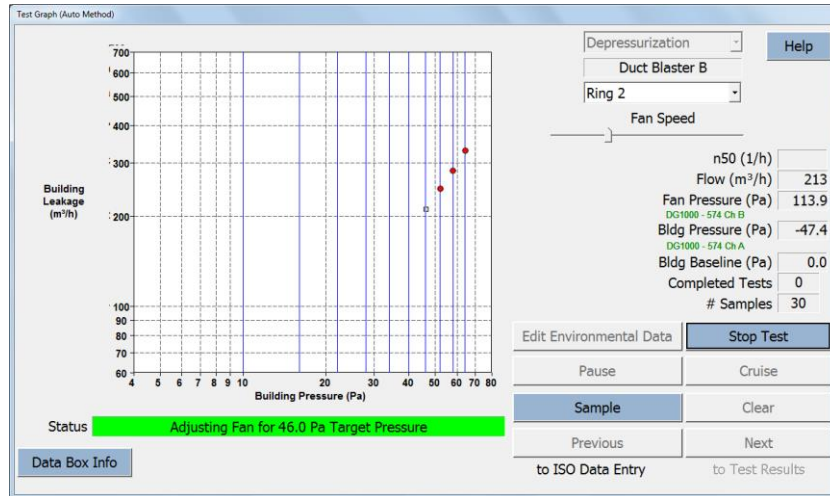

Fig. 5.24



Fig. 5.25

To perform a semi-automated test:

- Turn the speed controller carefully and slowly with your hand.
- Then, wait until the cursor is more or less stable. It takes some time to attain stable pressure – do not make any unnecessary adjustments while waiting.
- If the cursor is stable then press the button **Sample** to collect the data for this target pressure.

i For more detailed information on the respective screens, notes, and warnings a **Help** button is provided for each screen.

Help

6 Creating a test report

The TECTITE Express program allows you to print, preview or create a PDF file for a set of preformatted reports including a Detailed Test Report and a Test Graph.

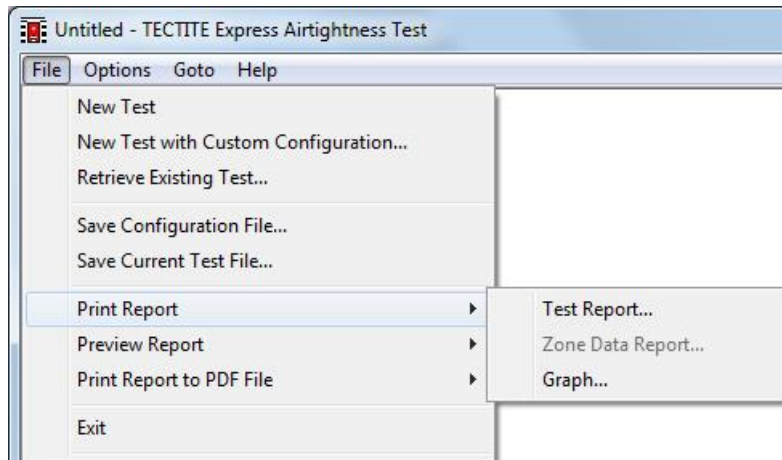

Fig. 6.1

Report printing and previewing options are available by clicking on **File** in the Main Menu.

The printing and preview functions within TECTITE Express utilize the printer drivers and configuration options currently installed in your computer.

To provide a report to PDF File it is to use the TEC PDF Writer (→ Chap.2.2).

Note:

The report format is dependent on the Test Standard selected in the *Test Settings* screen.

6.1 Detailed Test Report

The detailed Test Report contains a complete listing of the building data, test data, test results, as well as any comments input into the *Comment* screen.

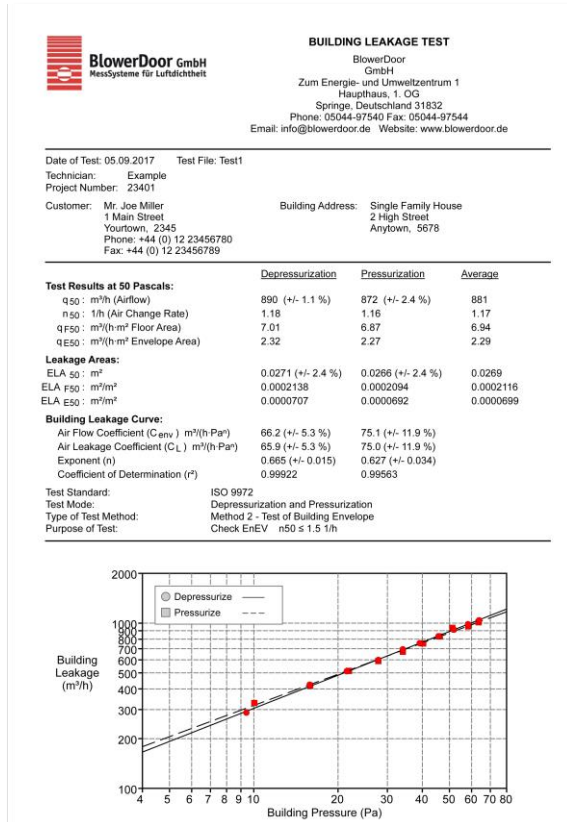
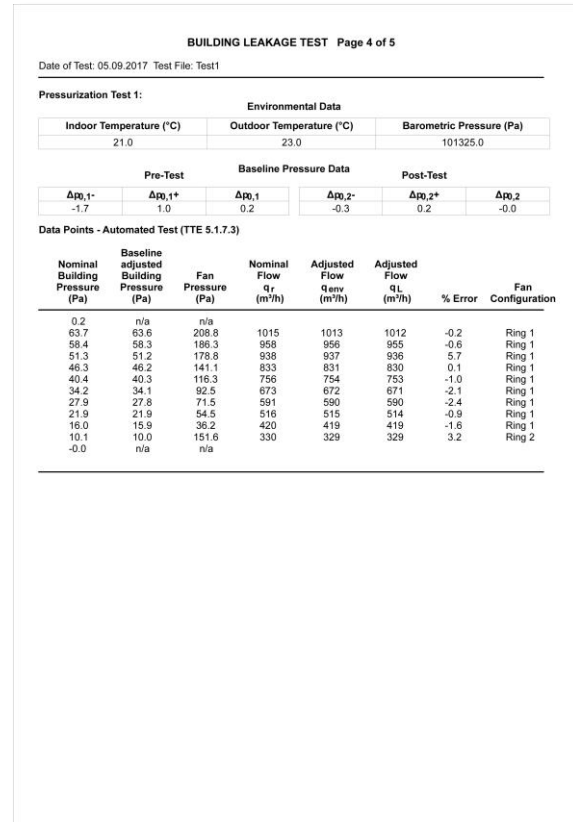

Fig. 6.2



6.2 Test Graph

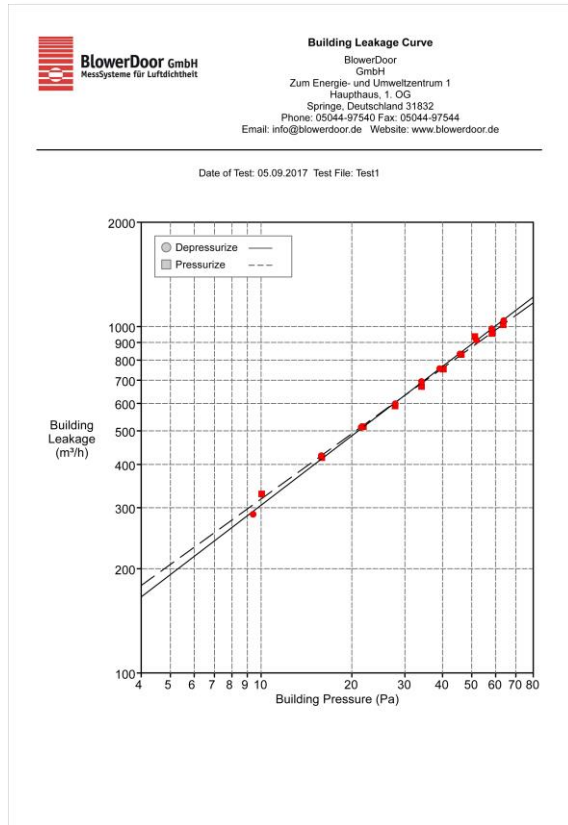

Fig. 6.3

The Test Graph is similar to the graph of fan airflow (or leakage) vs. building pressure from the *Test Graph* screen. It can be used to visually estimate the relationship between air leakage and building pressure.

6.3 Creating a PDF File of the Test Reports

TECTITE Express makes it easy to create a PDF file of any of the reports. Simply choose the **Print Report to PDF File** option, and then enter the name and location of the file to be saved in the file save window that appears. Once created, these files can be viewed on any computer that has PDF viewing software installed.

6.4 Putting Business Name and Logo on the Reports

The name, address, and contact information for your business can be placed at the top of the first page of all printed reports by completing the **Business Info** window.

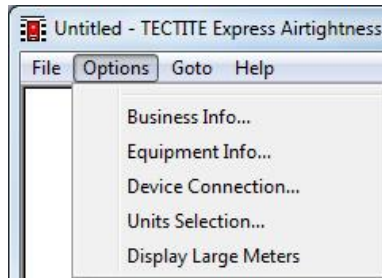

To access the **Business Info** window, click on **Options** in the Main Menu, and then select **Business Info...**

Fig. 6.4

Fig. 6.5

Information entered in the **Business Info** window is saved as part of the data files.

To insert a logo at the top of the printed reports, simply click on the **Load New Logo** button. In the **Select Logo File** window which appears, find and select the desired image file from your computer. TECTITE Express allows you to choose the following file types for a logo image: BMP, JPG, TIFF, and EMF.

7 Leakage Detection Using the DG-1000's Cruise Control (without laptop)



Fig. 7.1

Automatic one-point measurement at a constant building pressure differential can be executed optionally at 50 Pa, 25 Pa, 75 Pa, and -0 Pa and +0 Pa as well as at a customer defined pressure differential, with BlowerDoor system including DG-1000 (without laptop).

Remote controlling the DG-1000 via TECTITE Express or via a mobile device with the app TEG-Gauge is also possible. The app is available free of charge at the Apple App Store and at the Google Play Store.

Testing air barriers during construction with a BlowerDoor system is crucial to ensuring a good building envelope. During construction, it is easy to detect and fix leaks in the air barrier. A constant pressure differential of 50 Pa is generated in the building. As leaks are fixed, the DG-1000's Cruise Control feature automatically adjusts the BlowerDoor fan to maintain the 50 Pa pressure differential. The DG-1000 also displays the volume flow rate through the BlowerDoor fan.

The Cruise Control feature on the DG-1000 also allows you to quickly assess the airtightness of existing buildings.

No measurement according to European Standard

 **The one-point measurement is no substitute for a measurement according to standard (EN 13829 or EN ISO 9972). If a test that conforms to the standard is required, the test must be performed with a series of measurements, a laptop, and TECTITE Express.**

Please contact us for information on manual tests.

7.1 Conducting the Test

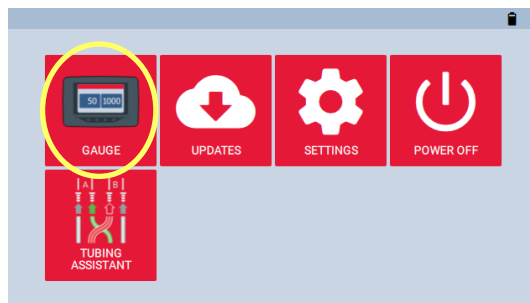

Fig. 7.2

Turning on DG-1000 and launching Gauge App

- Turn on the DG-1000 pressure gauge by pressing and holding the power button for approx. 3 seconds until the green power indicator light turns on, and wait until the DG-1000 is booted. The bootup process may take up to 40 seconds to complete, and the gauge is ready to be used when the home screen appears (shown below).
- Touch "Gauge" to start Gauge App.

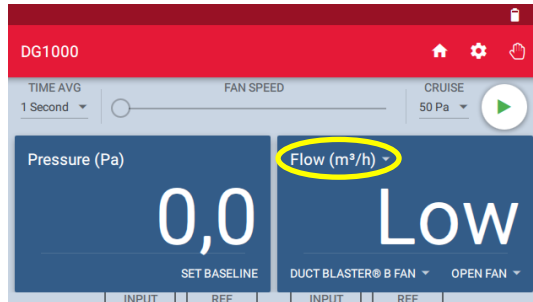

Fig. 7.3

Selecting the measuring mode

When the device turns on, it is set to **Pressure (Pa)** (channel A, see on the top in the left cell). For channel B, the last selected setting is set (see on the top in the right cell).

- To change, touch the currently displayed measurement mode at the top of the right cell.

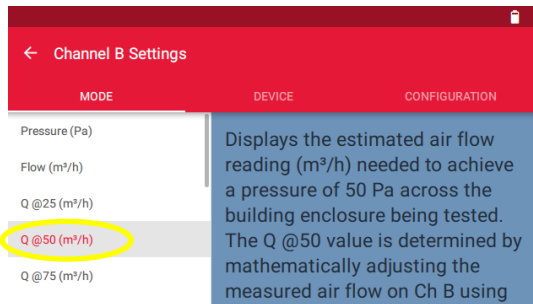



Fig. 7.4

- Select mode **Q@50 (m³/h)** on Channel B. "Q" signifies flow.

In this mode, Channel A measures the building pressure differential. Channel B displays the calculated airflow at 50 Pa. The magnitude of this airflow depends on the size of the flow ring installed and the speed of the fan.

- Use the arrow  to return to gauge screen.

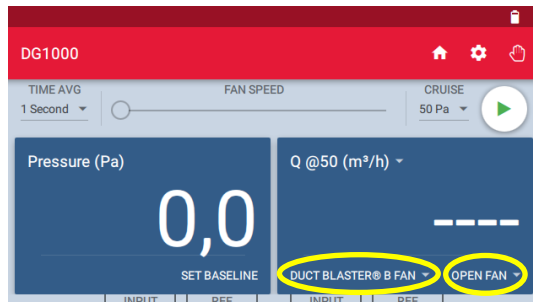
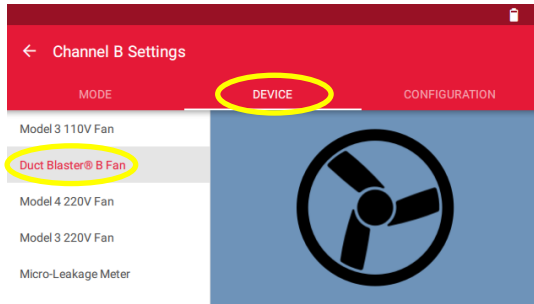



Fig. 7.5

Choosing the fan model and the flow ring

- Install the desired flow ring on the fan. It is recommended to begin with a ring (to avoid excessive pressure differentials).
- On the DG-1000, the fan model and the flow ring configuration must be set accordingly.
- To change, touch the currently displayed fan model or ring at the bottom of the right cell.



- Select the fan model and the installed flow ring on the DG-1000. The current fan model and flow ring appears at the bottom of the right cell of the display. “DuctBlaster B fan” and “open fan” configuration is preselected.
- Use the arrow  to return to gauge screen.

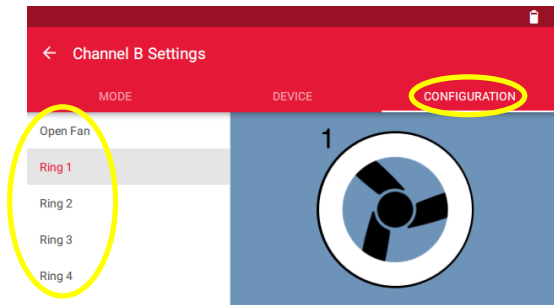

Fig. 7.6



Fig. 7.7

Turning on the speed controller

Turn on the speed controller switch only when the knob is turned completely to minimum.

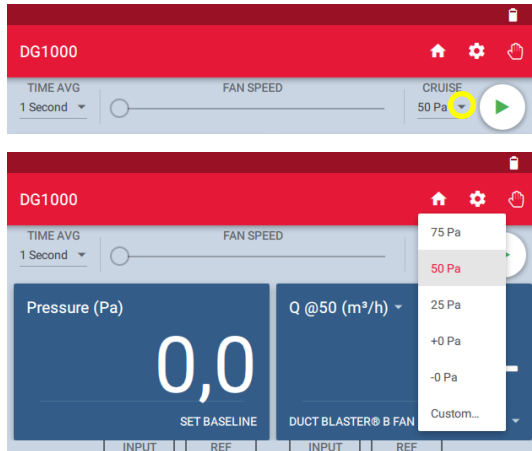

Fig. 7.8

Target pressure

- Touch the small gray triangle under “CRUISE” to display the target pressure differentials and select or enter them manually.

A target pressure of 50 Pa is preset.

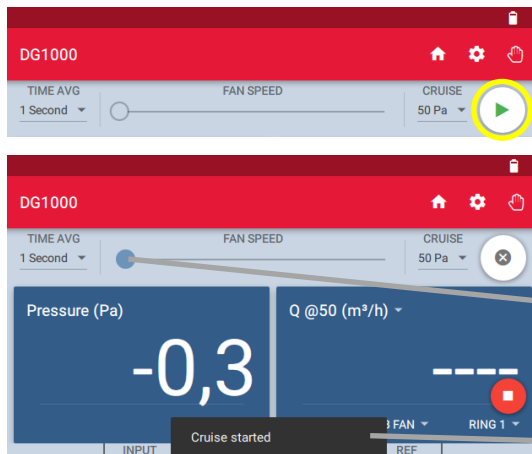

Fig. 7.9

Activating the Cruise Control on the DG-1000

- Press the Play icon to the start cruise function. The fan is automatically adjusted to the selected building pressure difference (target pressure).

The fan speed controller starts to move.

The display of the play icon changes to a stop icon and a red stop icon appears in the lower right corner of the screen.

A pop-up at the bottom of the screen indicates for a brief moment “cruise started”.

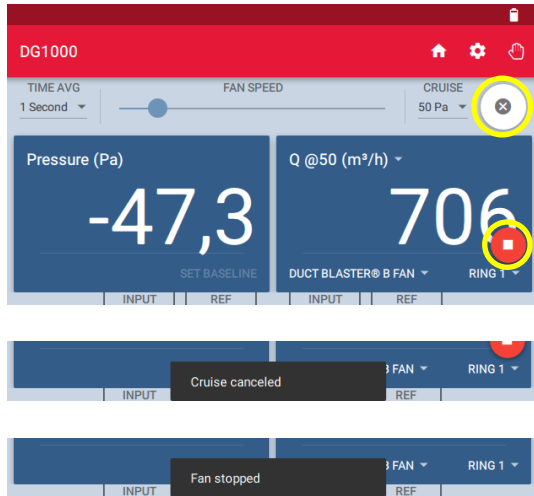



Fig. 7.10

The Channel A shows the pressure difference.

The Channel B shows the estimated airflow at 50 Pa V_{50} in m^3/h .

Stopping the test

- Cruise will turn off when the  is touched, but the fan will continue running. A pop-up will appear at the bottom of the screen with the message “Cruise canceled.”
- Touch the red stop icon  in the bottom right corner of the screen to stop the fan. When the fan is stopped a pop-up will appear at the bottom of the screen with the message “Fan stopped.”

Note all values before switching off the fan and the DG-1000!

Note:

The red stop icon will appear on all screens within the Gauge app during cruise, so the fan can be stopped from any screen within the Gauge app.

If the Home screen is opened during cruise, the fan will automatically stop!

7.2 Notes on the DG-1000 Display

7.2.1 Display of air flow at 50 Pascal

The DG-1000 automatically estimates the air flow at 50 Pa using the following formula:

$$\text{Estimated air flow rate (m}^3\text{/h) at 50 Pa} = \text{Measured air flow rate (m}^3\text{/h)} \cdot [50 \text{ Pa} / \text{current test pressure (Pa)}]^{0,65}$$

7.2.2 Display of other specific values on channel B

Values can be displayed, for example:

- Actual pressure differential: *Pressure (Pa)*
- Actual air flow rate: *Q (m³/h)*
- Calculated airflow rate at 25 Pa, 50 Pa, 75 Pa: *Q @xx Pa (m³/h)*
- Air change rate: *n₅₀* – in order to display it is required to enter the building volume in the gauge app settings.
- Air permeability: *Q @50 Pa (m³/h)/m²* – in order to display it is required to enter the building envelope area in the gauge app settings.
- Air leakage rate per net floor area: *Q @50 Pa (m³/h)/m²* – in order to display it is required to enter the net floor area in the gauge app settings.

7.2.3 Input of building area and building volume

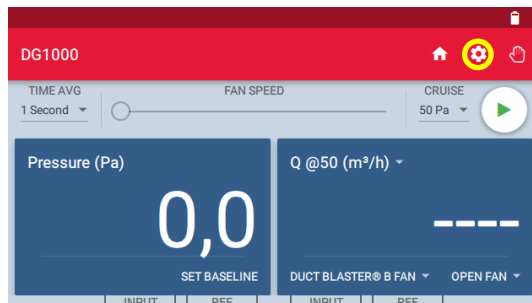



Fig. 7.11

To enter the building reference values, open the „Settings“ menu at gauge app by touching the gear icon .

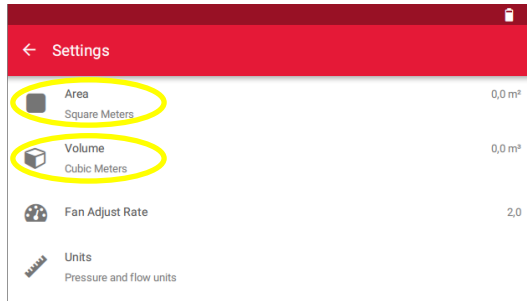



Fig. 7.12

Touch “Area” or “Volume” to enter the values and confirm with “OK”.

Use the arrow  to return to gauge screen.

Changing flow rings

Turn off the fan before changing the flow ring. Then set the flow ring configuration on the DG-1000.

Beeping sound during Cruise

If the chosen flow ring is too small for the building (if a test pressure of 50 Pa can't be reached), you will hear a beeping sound from the DG-1000. End the test, and install the next largest flow ring on the fan. Set the new flow ring configuration on the DG-1000 and then begin the new test. Turn off the fan before changing the flow ring.

Channel B shows “Low” instead of a flow reading

“Low” appears in the Channel B display when the flow ring is too large. In this case, the air flow being measured is below the range of the flow ring. Repeat the test with the next smallest ring. Make sure the fan is off before changing the ring.

Possible causes:

- The building envelope is very tight.

Strong fluctuations

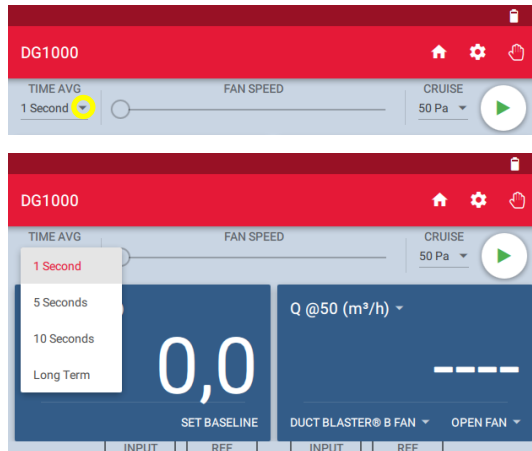

Fig. 7.13

If the display is fluctuating, change the time averaging setting on the gauge and choose the 5 or 10 second or Long-term averaging period. The default period is 1 second.

To change, touch the small gray triangle next to "1 second" (= pre-set measurement time interval).

Channel B shows "Polarity"

If "Polarity" appears in the right display, the tubes on channel B are probably interchanged. Please check the connections (→ Chap. 4.5.4 and Chap. 4.6).

Appendix A: Technical Data

The accuracy of the measuring systems BlowerDoor MiniFan, BlowerDoor Standard and BlowerDoor MultipleFan meets the requirements of the following test standards: ISO 9972, EN 13829, FD P50-784, ASTM E779, ASTM E1554, CGSB-149.10-M86, ATTMA TS 1, NFPA, RESNET und US ACE as well as ISO 14520, EN 15004, VdS 2380 and 2381.

A.1 Minneapolis BlowerDoor MiniFan (with DuctBlaster B fan) and controller

Performance:	5 m ³ /h – 2,300 m ³ /h at a pressure differential of 50 Pa
Accuracy:	With open fan, rings 1– 3: ±4 % of reading, or ± 1.7 m ³ /h (the higher value is valid). With ring 4: ± 4 % of reading, or ± 0.9 m ³ /h (the higher value is valid)
Electrical Input:	100-240 V, 50-60 Hz, max power consumption 3.0 A, 1 Ph.
Fan Over-Current Protection Fuse:	250VAC/5AF VDE/UL approved.
Fan Motor Rating:	< 240 Watt, Class H Insulation, Thermally Protected.
Fan Control Jack Isolation Rating:	V _{ISO} > 2500 V _{RMS} .
Operational Environment:	0° to +45° C, 10-90% R.H. (non-condensing) up to an altitude of 3,000 m
Fan Weight:	2.7 kg
Dimensions:	∅ 345 mm

A.2 Pressure Gauge DG-1000

Number of Pressure Channels:	two (independent)
Pressure Range:	- 2.500 Pa to + 2.500 Pa
Display Resolution:	0.1 Pa for readings 0 – 999.9 Pa 1 Pa for readings 1000 Pa and larger
Accuracy at Typical Use Conditions ¹ :	± 0.9 % of pressure reading or ± 0.12 Pa (whichever is greater)
<i>¹) Typical conditions are a temperature range of 12,2° to 32,3° C, and a regular calibration interval</i>	
Recommended Calibration Interval:	2 years
Units of Measure:	Channel A: pressure differential in Pa or in. H ₂ O Channel B: pressure differential in Pa or in. H ₂ O; Airflow in m ³ /h, l/s or cfm; Airflow @ 25, 50 or 75 Pa in m ³ /h, l/s or cfm; Air Change Rate n ₅₀ in 1/h; Airflow per unit area @ 25, 50 or 75 Pa in (m ³ /h)/m ² , (l/s)/m ² or cfm/ft ²
Automatic zeroing:	On start up and then once every 10 seconds. Tilt and motion compensation between auto-zeros.
Display/Touch Screen:	(L x H) 480 x 272 pixels, 9.5 x 5.3 cm, capacitive touch screen
Display Backlight:	User adjustable (default 40%)
Time Averaging:	1 second, 5 second, 10 second or long-term average (continuous update)
Operating Temperature Range ² :	5.5° C to 46° C
Storage Temperature Range:	-20° C to 60° C

Pressure Gauge DG-1000 continued

Power:	Two lithium-ion batteries (rechargeable and replaceable; size 18650, 2600 mAh, 3.7 V, protected), charging via the supplied USB-C-charger
Battery Life:	Over 15 hours of continuous use with default settings, 13 hours of continuous use with default settings and WiFi active
Auto-Off	Adjustable from 10 minutes to never (= no auto off)
Dimensions:	(L x W x H) 177 x 107 x 36 mm
Weight:	approx. 445 g
Compatibility:	Compatible with all TEC devices
Stand-alone:	Cruise control for one-point measurement: Automatically maintains a building pressure differential of 0, 25, 50, 75 Pa or customer defined pressure differential.
Connections to PC/laptop:	WiFi, USB and Ethernet connection
Connections to mobile devices:	WiFi, Bluetooth
In connection with a laptop:	Automated test, semi-automated test (TECTITE Express) Logging data of pressure differentials (TECLOG)

A.3 Software TECTITE Express

Version	5.1
Indication for Belgium	Software tested according to the specifications of annex 1 of STS-P 71-3.

A.4 BlowerDoor Mounting Frame and BlowerDoor Panel

BlowerDoor Mounting Frame standard size (adjustable)

Material:	Extruded aluminum
Minimum and maximum width:	0.71 m to 1.14 m
Minimum and maximum height:	1.32 m to 2.43 m
Seal:	EPDM flexible gasket

BlowerDoor Panel

Material	Nylon with built-in vinyl window
----------	----------------------------------

Appendix B: Calibration, Maintenance, and Care

B.1 DG-1000

Software-Update

For verification and to install updates of the operating software, the DG-1000 must establish an internet connection: Turn on the DG-1000 and connect it to a **stable internet connection** either via an Ethernet cable or wirelessly over WiFi (Join network). Connecting the DG-1000 to a computer using a USB cable or Bluetooth will NOT establish an internet connection and updates can NOT be installed.

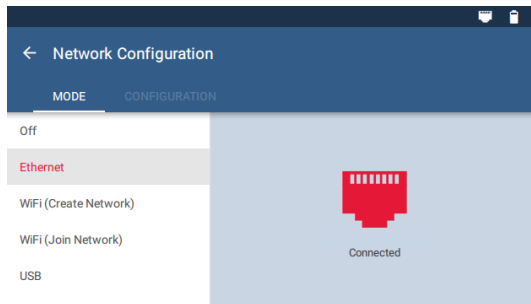

For connection via Ethernet, plug in the Ethernet cord into the DG-1000 Ethernet port and into a router with internet connection. Set the selected connection type in the DG-1000 menu “Settings” / “Network configuration”.

Fig. 8.1

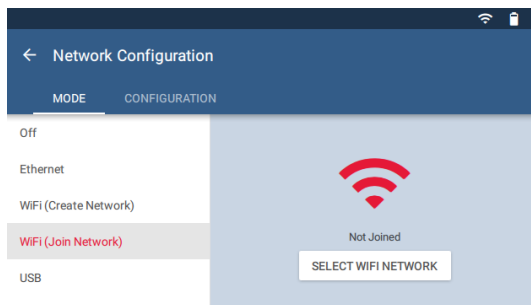

For a wireless connection to the Internet, select the menu “Settings” / „WiFi (Join network)” and touch on the right SELECT WIFI NETWORK (→ Chap. 2.3.2.2).

Fig. 8.2

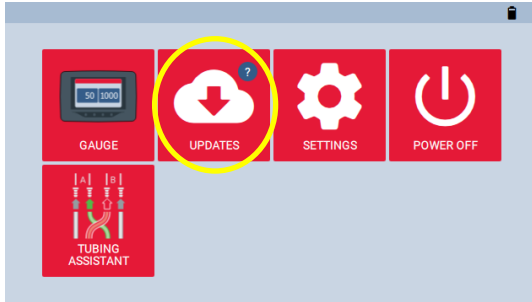



Fig. 8.3

Once an Internet connection is established, return to the home screen using the arrow  and the Home icon  and then select “Updates”.

The DG-1000 indicates if the device is already up to date (→ Fig. 8.4).

Any available updates will be listed on the left side of the Updates screen. To install an update, select the update from the list and touch the “Install” button. Follow the instructions.

Please ensure sufficient battery capacity of the DG-1000 for a smooth update!

After successful installation, touch “Power off” or “Reboot” to complete the update process.

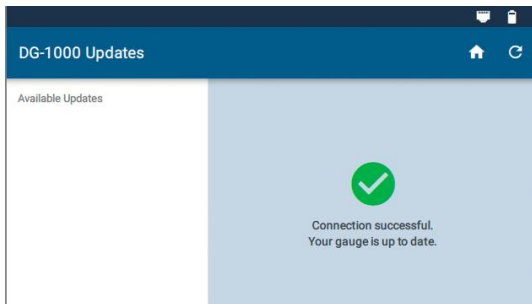

Fig. 8.4

Check that the DG-1000 successfully updated by going to the “Settings” screen and checking the software version.

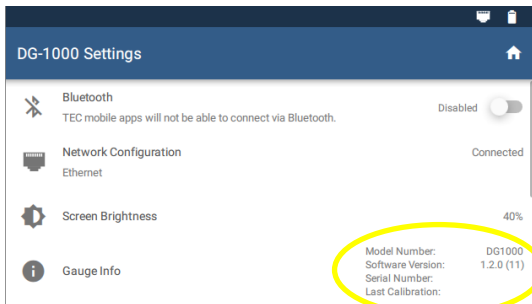

Fig. 8.5

Calibration

A calibration label is located on the back of the gauge that includes the gauge serial number and the date it was last calibrated. This information is also available in the DG-1000 settings screen.

We recommend recalibrating the DG-1000 every 24 months. During the recalibration process, the “as found” calibration of the gauge is tested and recorded. The calibration is then adjusted and the gauge is retested.

If damage is suspected, have the DG-1000 inspected by our service.

Safety, warnings and troubleshooting information

- Do not operate the gauge if any liquid gets inside the gauge.
- If the inside of the gauge gets wet, immediately turn off the gauge and remove the batteries. Leave the battery compartment cover off to allow for drying. Dry the batteries with a towel and allow the batteries to air dry for at least 12 hours. Allow the gauge to air dry for at least 12 hours before inserting the batteries and powering back on.
- If a liquid gets inside the pressure ports, contact the BlowerDoor GmbH.
- Do not attempt to dry any of the electrical connectors with a Q-Tip or similar item.

Lithium-ion batteries (rechargeable)

General information

The battery compartment of the DG-1000 is located on the back of the gauge. The DG-1000 uses two lithium-ion batteries that are rechargeable and replaceable. The manufacturer recommends using the Tenergy Li-Ion battery, size 18650, 3.7 V protected.

Safety and warnings

- Do not leave the batteries in direct sunlight or in an area heated by sunlight. The battery could generate heat, smoke or flames.
- Do not use the batteries when there is rust present, the batteries have a bad smell or if the batteries are damaged in any other way.
- Keep the batteries out of the reach of children and animals.

- If fluid from the battery leaks out and makes contact with skin, wash with soap and water. The fluid may cause irritation. If that happens please see a doctor immediately.
- Do not expose the batteries to extreme heat, flames or liquids.
- Do not modify or disassemble the batteries as this could result in leakage or explosion.
- When replacing the batteries in the gauge, use identical, fresh batteries.
- Always charge both batteries at the same time.

Battery run time, storage and recharge:

Battery run time is 15 hours, depending on network configuration mode and screen brightness. To help preserve the battery run time, we recommend keeping the screen brightness at or below 40% and to turn off WiFi when not needed.

All batteries self-discharge over time. The manufacturer recommends charging the batteries for a few hours once every three months using the included charger regardless of battery level. Batteries should be charged in temperatures between 9° C and 32° C.



Fig. 8.6

The batteries can be fully charged in about two hours using the USB-C port and included charger. Charge the batteries overnight for optimal battery performance. When the batteries are charging the indicator lights (green and amber) will be on. The amber light will turn off when the batteries are fully charged; it flashes if there is a charging error.

The DG-1000 will also be slowly charged when connected to a computer via a USB cable. When the gauge is connected, the USB-C indicator lights will be on.



Instructions for disposing of the batteries: *Batteries and accumulators do not belong to household waste, but must be disposed of separately.*

Touch screen – use and care

- A screen protector is included with the DG-1000. Replacement screen protectors can be purchased from BlowerDoor GmbH.
- To clean the screen, use the microfiber cloth included with the DG-1000.
- Do not clean the screen with flux, water, acetone, ethanol, isopropyl alcohol, toluene or ammonia (glass cleaner).

Maintenance

- Operating temperature: 5.5° C to 46° C
- Storage temperature: -20° C to 60° C
- Avoid condensation (for example, when switching between dry and moist environments).
- Do not store the gauge in areas where it may come into contact with chemical vapor. The vapor can cause corrosion.
- Do not use the gauge when the batteries should be replaced (measurements may be inaccurate).
- Do not expose the gauge to excessive pressure.
Note: It is easy to slam the gauge in doors during tests.

Reset DG-1000

A recovery disk (micro-SD card) is available from BlowerDoor GmbH. It should be used only if you need to reset the DG-1000 to the factory settings. **If a situation arises where the recovery disk may need to be used, consult with BlowerDoor GmbH technical support.**

B.2 BlowerDoor Fan

Calibration parameters for DuctBlaster B and rings

Fan configuration	Calibration parameters		
	Air flow readings	C	n
Open fan	flow (m ³ /h) =	184.7	· (fan pressure in Pa) ^{0.5032}
Ring 1 installed	flow (m ³ /h) =	68.81	· (fan pressure in Pa) ^{0.5038}
Ring 2 installed	flow (m ³ /h) =	25.94	· (fan pressure in Pa) ^{0.5064}
Ring 3 installed	flow (m ³ /h) =	9.922	· (fan pressure in Pa) ^{0.5140}
Ring 4 installed	flow (m ³ /h) =	1.808	· (fan pressure in Pa) ^{0.5020}

Note:

All air flow measurements shown on the DG-1000 are adjusted to an air density standard of 1.204 kg/m³. This corresponds to an air density under ambient conditions of 20° C and 101325 Pa. The adjustment is based on the CGSB regulation CAN/CG-SB-149.10-M86. This measurement does not include the actual airflow through the fan.

To find the actual air flow, use the formula provided by the manufacturer:

$$\text{airflow}_{\text{measured}} (\text{m}^3/\text{h}) = \text{airflow}_{\text{reading}} (\text{m}^3/\text{h}) \cdot \sqrt{\frac{1.204 \text{ kg/m}^3}{\text{Air density (kg/m}^3 \text{ *)}}}$$

*) Density of the air that flows through the fan. With negative pressure in the building, that is the density of the inside air. With positive pressure in the building, that is the density of the outside air.

Note:

TECTITE Express, the accompanying program, corrects the airflow automatically.

Calibration

We recommend that the fan be recalibrated every four years. Contact our office for more information.

With the exception of damage, the fan should retain its factory-set calibration settings between the recommended calibrations. Damage may include damage to the flow sensor, shifting of the motor or blades within the fan housing, damage to the housing itself, and leaks in the tubing or flow sensor. Periodically check the fan for damage.

Minimal fan pressure of rings

Ring	Min. fan pressure (Pa)
Open fan	25
Ring 1	25
Ring 2	25
Ring 3	3
Ring 4	5

The fan is calibrated to a pressure differential of up to 80 Pa, but can be calibrated to differentials of up to 100 Pa. To do this, the data points must lie on the line of best fit.

Maintenance

Periodically examine the fan regarding the motor position, the tightness of flow sensor and tubing, and a tight fitting of the connection trim. Furthermore, the fan should always be free from dust deposit.

Testing the motor position

To test the motor position, remove all rings. Lay a straight edge upright over the fan housing. Use a ruler or a yard stick to measure the distance between the straight edge and the motor, and then compare to the permissible motor distance.

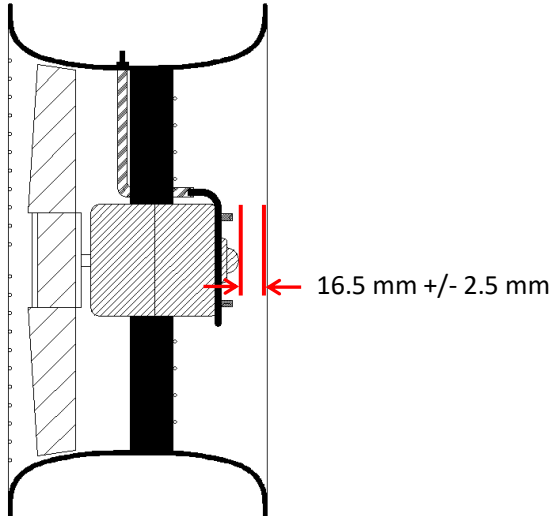

Fig. 8.7

Permissible distance from housing (without rings) to motor: 16.5 mm +/- 2.5 mm.

If the permissible distance is exceeded, the fan must be sent to BlowerDoor GmbH for calibration and repairs.

Testing the flow sensor

The DuctBlaster B fan is equipped with a pressure sensor to determine the air flow from the fan and the installed ring. The sensor is made of thin stainless steel tubing.

Regularly check that the flow sensor does not appear broken and attaches tightly to the fan.



Fig. 8.8

Flow sensor

Regularly test the flow sensor and tubing for leaks.

Find the three pin holes in the steel tubing on the back of the sensor. Temporarily seal them, e.g. with masking tape. Attach a piece of tubing to the connector at the fan marked in red. Next, suck on the open end of the tube; if there are no leaks in the tubing, a vacuum will be created. If you cannot create a vacuum, send the fan in for repairs.

Remove the tape.

Cleaning the fan

Use a damp cloth to remove dust deposits on the motor, rings, blades, and housing.

Note: Keep the air intake free of obstacles.

B.3 Fan Speed Controller

If the DuctBlaster fan stops running or fails to respond to speed commands:

- Verify that the fan speed controller is turned **ON**.
- Verify that the fan speed controller power cord is plugged into an AC power mains outlet.
- Verify that the AC power mains outlet has electrical power.
- Verify that the fan connect cord from the fan speed controller is plugged into the receptacle located on the fan electrical box.
- Turn the fan speed control knob from minimum to maximum and back to minimum. If the fan fails to respond then the internal fuse may be blown and need to be replaced.



**CAUTION – HAZARDOUS VOLTAGES INSIDE SPEED CONTROLLER.
UNPLUG POWER CORD FROM AC POWER MAINS OUTLET BEFORE SERVICING SPEED CONTROLLER.**

Replacement Fuse Specification: 5 Amp, 250 VAC, 5 X 20 mm, FAST acting, approved by VDE/UL.

Fuse replacement is **not** a user serviceable repair. Fuse replacement can only be undertaken by qualified repair personnel. Contact your local distributor for a listing of qualified repair facilities or the BlowerDoor GmbH.

Appendix C: Expansion Capabilities of the BlowerDoor Measurement System

Set-up possibility of BlowerDoor Standard (with measuring fan model 4) – WiFi connection

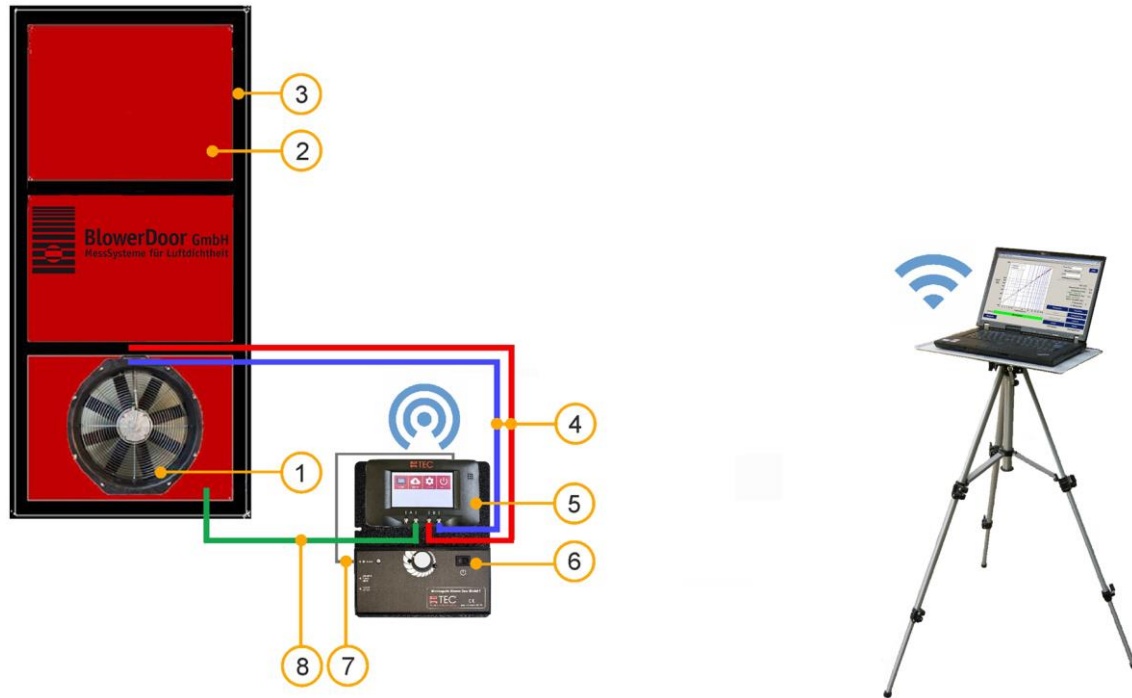

- | | | | |
|---|--|---|---|
| 1 | BlowerDoor standard fan (model 4) | 6 | Fan speed controller |
| 2 | BlowerDoor panel standard size | 7 | Fan control cable [connection DG-1000 – controller] |
| 3 | BlowerDoor mounting frame standard size | 8 | Set of tubes [capture outside pressure, inside green (3 m), outside transparent (10 m)] |
| 4 | Set of tubes [connection fan – DG-1000, red and blue (3 m each)] | | |
| 5 | Pressure gauge DG-1000 | | |

Fig. 9.1

Set-up possibility of BlowerDoor MultipleFan (1 standard measuring fan + 1 DuctBlaster B fan) – WiFi connection

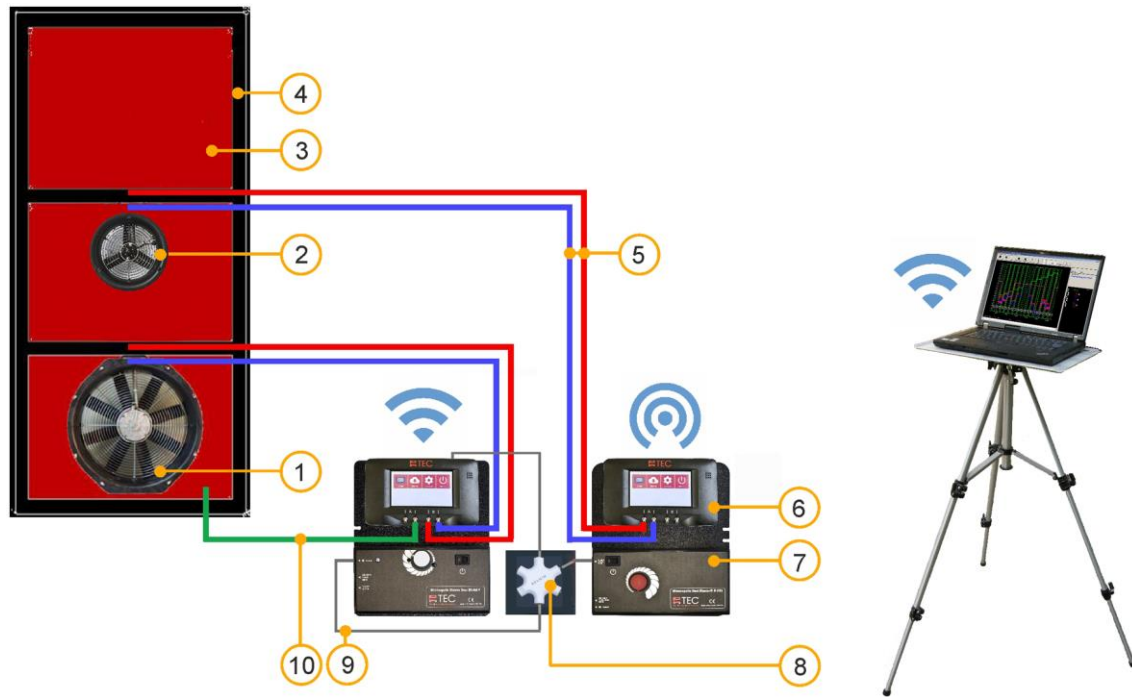

- | | | | |
|---|---|----|---|
| 1 | BlowerDoor standard fan (model 4) | 6 | Pressure gauge DG-1000 (2 pcs) |
| 2 | BlowerDoor fan (DuctBlaster B fan) | 7 | Fan speed controller (2 pcs) |
| 3 | BlowerDoor panel standard size with 2 openings for 1 standard fan and 1 DuctBlaster B fan | 8 | Communication jack |
| 4 | BlowerDoor mounting frame standard size | 9 | Cable with jack plugs (2 pcs) |
| 5 | Set of tubes [connection fan – DG-1000, red and blue (3 m each)] (2 pcs) | 10 | Set of tubes [capture outside pressure, inside green (3 m), outside transparent (10 m)] |

Fig. 9.2

Set-up possibility of BlowerDoor MultipleFan (3 fans) – WiFi connection

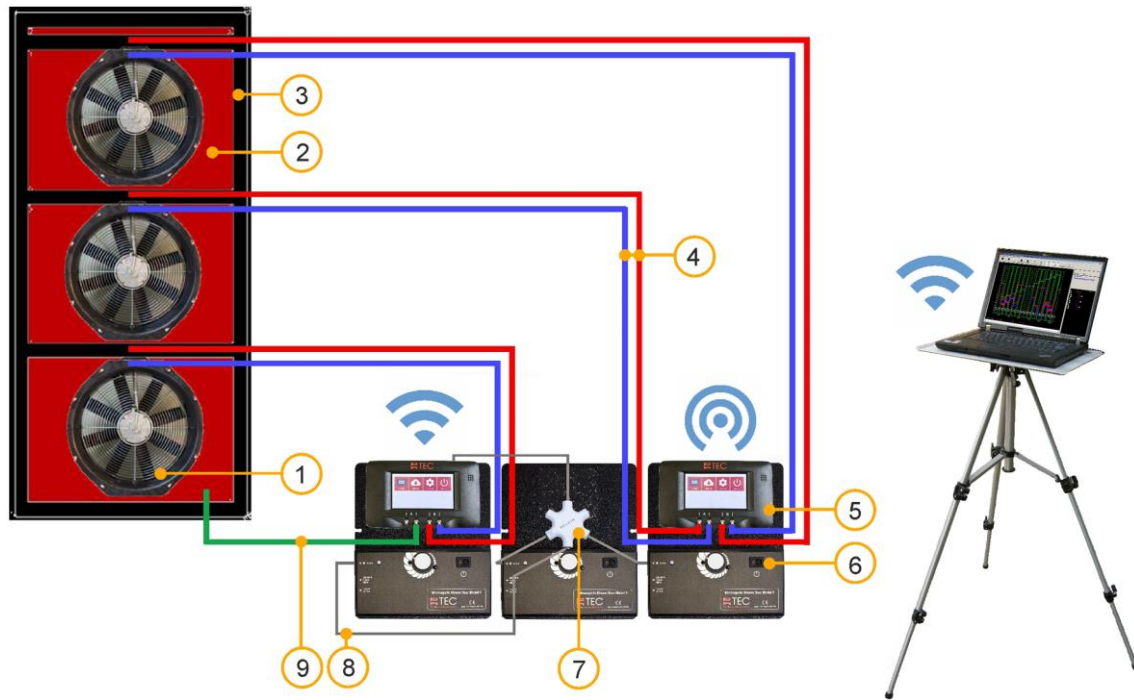

- | | | | |
|---|---|---|---|
| 1 | BlowerDoor fan (3 pcs) | 5 | Pressure gauge DG-1000 (2 pcs) |
| 2 | BlowerDoor panel standard size with 3 openings | 6 | Fan speed controller (3 pcs) |
| 3 | BlowerDoor mounting frame standard size + additional upper/middle cross bar | 7 | Communication jack |
| 4 | Set of tubes [connection fan – DG-1000, red and blue (3 m each)] (3 pcs) | 8 | Cable with jack plugs (3 pcs) |
| | | 9 | Set of tubes [capture outside pressure, inside green (3 m), outside transparent (10 m)] |

Fig. 9.3

Set-up possibility of BlowerDoor MultipleFan (3 fans) – cable connection

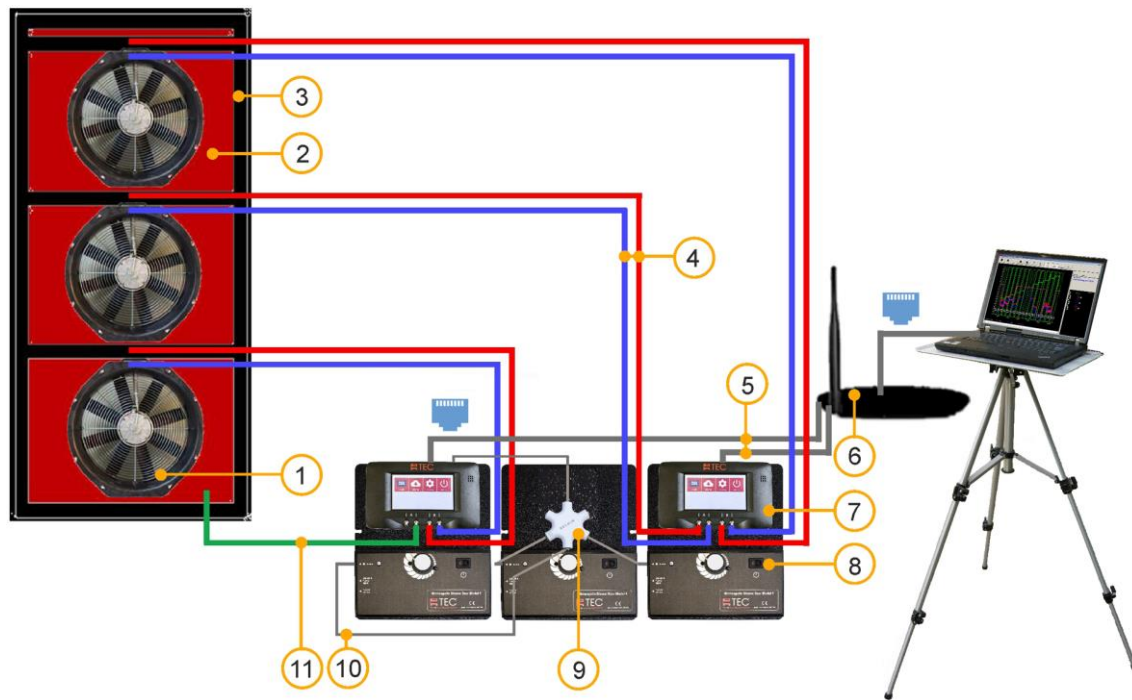

- | | | | |
|---|--|----|--|
| 1 | BlowerDoor fan (3 pcs) | 6 | Router (DHCP) incl. Ethernet cord (10 m)
[connection router – laptop] |
| 2 | BlowerDoor panel standard size with 3
openings | 7 | Pressure gauge DG-1000 (2 pcs) |
| 3 | BlowerDoor mounting frame standard size +
additional upper/middle cross bar | 8 | Fan speed controller (3 pcs) |
| 4 | Set of tubes [connection fan – DG-1000,
red and blue (3 m each)] (3 pcs) | 9 | Communication jack |
| 5 | Ethernet cable (2 pcs) [connection DG-1000 –
router (2 m)] | 10 | Cable with jack plugs (3 pcs) |
| | | 11 | Set of tubes [capture outside pressure, inside
green (3 m), outside transparent (10 m)] |

Fig. 9.4

Set-up possibility of BlowerDoor MultipleFan (1 + 2 fans) – WiFi connection

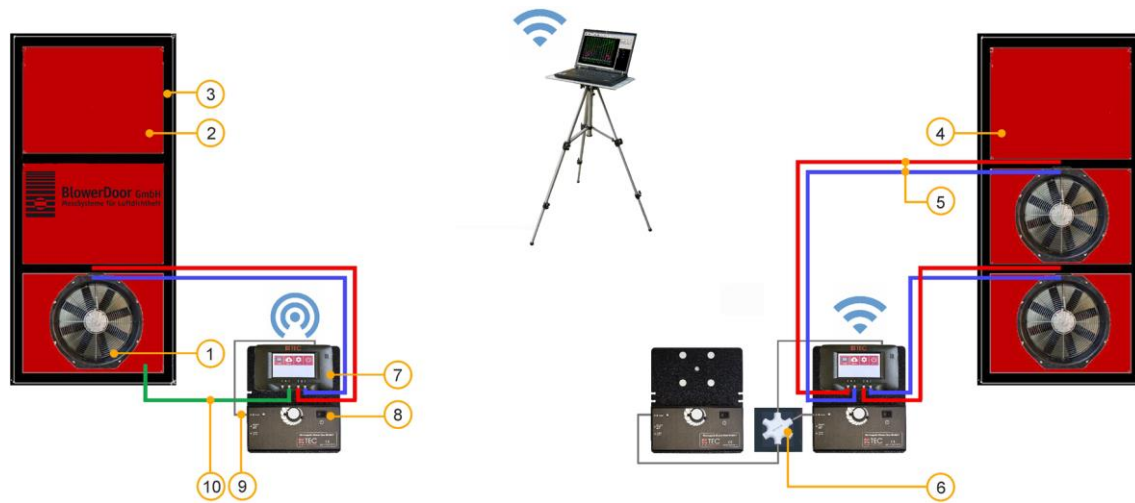

- 1 BlowerDoor fan (3 pcs)
- 2 BlowerDoor panel standard size
- 3 BlowerDoor mounting frame standard size (2 pcs)
- 4 BlowerDoor panel standard size with 2 openings
- 5 Set of tubes [connection fan – DG-1000, red and blue (3 m each)] (3 pcs)
- 6 Communication jack
- 7 Pressure gauge DG-1000 (2 pcs)
- 8 Fan speed controller (3 pcs)
- 9 Cable with jack plugs (3 pcs)
- 10 Set of tubes [capture outside pressure, inside green (3 m), outside transparent (10 m)]

Fig. 9.5

Set-up possibility of BlowerDoor MultipleFan (6 fans)

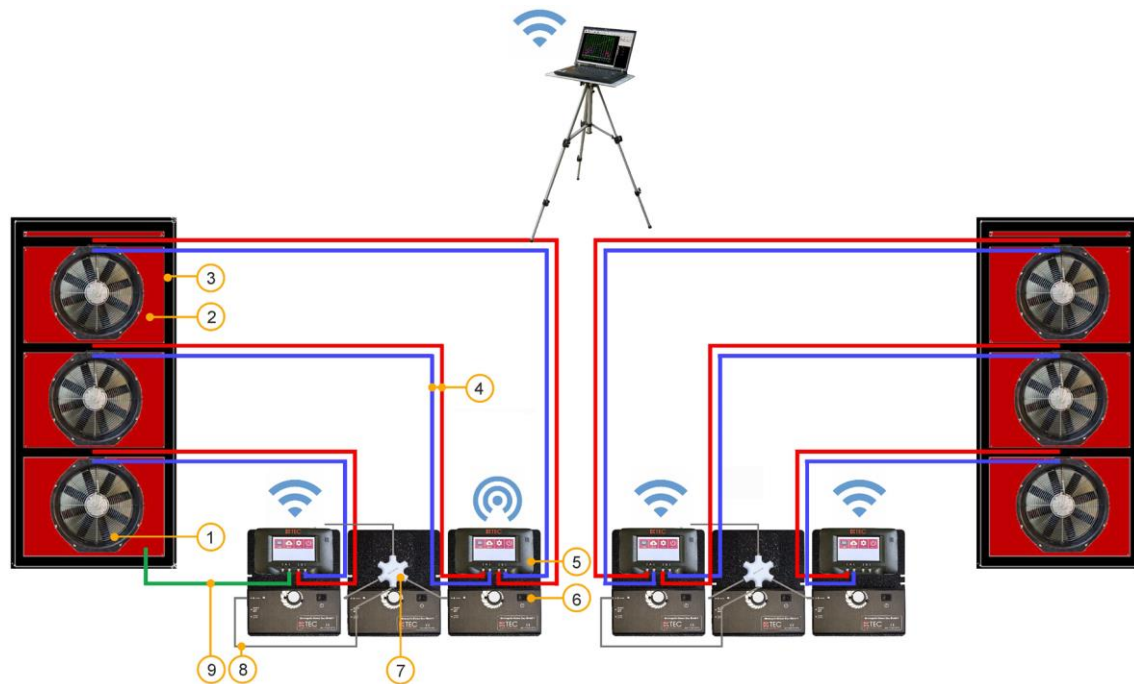

- | | | | |
|---|--|---|---|
| 1 | BlowerDoor fan (6 pcs) | 5 | Pressure gauge DG-1000 (4 pcs) |
| 2 | BlowerDoor panel standard size with 3 openings (2 pcs) | 6 | Fan speed controller (6 pcs) |
| 3 | BlowerDoor mounting frame standard size + additional upper /middle cross bar (2 pcs) | 7 | Communication jack (2 pcs) |
| 4 | Set of tubes [connection fan – DG-1000, red and blue (3 m each)] (6 pcs) | 8 | Cable with jack plugs (6 pcs) |
| | | 9 | Set of tubes [capture outside pressure, inside green (3 m), outside transparent (10 m)] |

Fig. 9.6

Our Service Offer

Calibration of your BlowerDoor Measurement Systems

The accuracy of the BlowerDoor testing flow rings at 4% as well as that of the pressure gauge DG-1000 at $\pm 0.9\%$ clearly exceed the legal minimum requirements.

To maintain the high measuring accuracy of the BlowerDoor Measurement System, we recommend ensuring regular calibration: For the DG-1000, adjustment and manufacturer's calibration is recommended at an interval of two years. The accuracy of the BlowerDoor testing fan should be checked by calibration every four years. A previous fan check forms part of each fan calibration. The requirements of the national legislation should be considered for pressure gauge and fan.

In addition to the very high quality manufacturer's calibration, BlowerDoor GmbH also offers accredited calibrations with DAkkS calibration, which are conducted according to a standard defined by the German accreditation body (Deutsche Akkreditierungsstelle GmbH, DAkkS).

BlowerDoor GmbH offers calibration of fans and of pressure gauges at favorable prices. Details are available on www.blowerdoor.com.

Seminars and in-house training

In addition to the extensive seminar program covering aspects of an airtight building envelope offered by the Energie- und Umweltzentrums am Deister, BlowerDoor GmbH and its contract partners also provide individual training on site or on-demand webinars. Contact us for more information!

Service at your construction site

If required, we will lend our competence to support you in conducting a BlowerDoor measurement at your construction site. Contact us for an offer tailored to your needs!

Listing in the directory of providers of BlowerDoor measurements

As a BlowerDoor testing team, your listing in our online database is free of charge. Contact us at info@blowerdoor.com if you would like an address entry, including a link to your email address and website in our directory of BlowerDoor test providers.

CompetenceCenter

All BlowerDoor testing teams receive access to our virtual Center of Competence at www.blowerdoor.com free of charge, where we regularly provide you with news and offer interesting information for download. Contact us if you have not yet received your client number and access data from BlowerDoor GmbH.

Advertising material for BlowerDoor testing teams

Upon request, we support BlowerDoor testing teams with professional printable files on BlowerDoor measurements free of charge. The material will feature your own contact data and company logo. (View a sample at www.blowerdoor.com.) If interested, send us an e-mail with your complete address and your company logo as a jpg file in printable resolution to info@blowerdoor.com.

Technical Support

Should you have unexpected technical problems while conducting BlowerDoor measurements, our tech support team is available free of charge during our office hours at the following number: +49(0)5044/975-57 (chargeable call to German landline).

Guarantee

Object of the guarantee:

BlowerDoor standard, BlowerDoor MiniFan and BlowerDoor MultipleFan system

Besides the guarantee set forth in the law, BlowerDoor GmbH offers you a total of four years of guarantee for the complete BlowerDoor Measurement System (BlowerDoor fan including flow rings and fan cover, DG-1000, mounting frame and nylon panel, speed controller, tube set, and accessory bag). The guarantee starts with date of purchase. It takes into account all claims under guarantee submitted to BlowerDoor GmbH in writing during the period of guarantee.

Should a claim under guarantee require the measuring equipment to remain at the premises of BlowerDoor GmbH for more than 7 days, customers upon request will be loaned a corresponding replacement for the duration of the repairs. BlowerDoor GmbH will bear the cost of shipping to the client's premises on the basis of standard cost of freight. Upon repair and on receipt of the repaired measuring device, customers shall send the measuring device loaned to them back to BlowerDoor GmbH at their own expense immediately. The costs as well as the risk of loss or damage on the way to or from the point where the claims under guarantee are accepted are borne by the respective shipping party.

Claims under guarantee cannot be considered

- when the measuring device or the object under guarantee has not been operated according to specifications, e.g. has not been properly handled or stored, in particular also when the operating instructions have not been observed or maintenance has been neglected,
- when the measuring device or the object under guarantee has been opened or repaired by non-authorized workshops or other people,
- when the measuring device or the object under guarantee shows damages that can be traced to wear or tear.

In accordance with this guarantee, BlowerDoor GmbH shall only provide guarantee services if the guarantee case is immediately and without any delay communicated to BlowerDoor GmbH in writing.

This guarantee shall not cover consequential damages, in particular financial losses for the customer caused by failure of the equipment.

Upon completion of the guarantee service, ownership of the parts replaced shall fall to BlowerDoor GmbH.

Process/Delivery

Only BlowerDoor GmbH, Zum Energie- und Umweltzentrum 1 in 31832 Springe-Eldagsen/Germany (Tel.: +49(0)5044/975-40) shall be entitled to accept claims under guarantee. Customers shall send the faulty measuring device or component to BlowerDoor GmbH. BlowerDoor GmbH shall bear the cost of return shipping on the basis of standard cost of freight.

The costs and risk of loss or damage on the way to or from the point where the claims under guarantee are received are borne by the respective shipping party.



EC-Declaration of Conformity

THE ENERGY CONSERVATORY
 2801 21st Avenue South, Suite 160
 Minneapolis, MN 55407
 USA

declares that the product

Minneapolis BlowerDoor DuctBlaster Series B

conforms to the council directives and harmonized standard requirements
 for Electrical Equipment for Measurement, Control, and Laboratory Use:

EC-Low Voltage Directive 2006/95/EC

EN 61010-1:2010

EC-EMC Directive 2004/108/EC

EN 61326-1:2006; Part 1

EN 61326-2-1:2005-12; Part 2-1

EN 55011:2009; A1:2010	EN 61000-4-4:2004; Corr 2006
EN 61000-3-2:2006; A1:2009; A2:2009	EN 61000-4-5
EN 61000-3-3:2008	EN 61000-4-6
EN 61000-4-2:2009	EN 61000-4-8:2010
EN 61000-4-3:2006; A1:2008; A2:2010	EN 61000-4-11

Certification Laboratory

EC-Low Voltage Directive 2006/95/EC:

TUV SUD America, Minneapolis MN

EC-EMC-Directive 2004/108/EC:

TUV SUD America, Minneapolis MN

European Representative:

BlowerDoor GmbH

MessSysteme für Luftdichtheit

Zum Energie- und Umweltzentrum 1

D-31832 Springe

Germany



Gary D. Nelson, President

The Energy Conservatory May 28, 2014



EC-Declaration of Conformity

THE ENERGY CONSERVATORY
 2801 21st Avenue South, Suite 160
 Minneapolis, MN 55407
 USA

declares that the product

TEC DG-1000

conforms to the council directives and harmonized standard requirements
 for Electrical Equipment for Measurement, Control, and Laboratory Use:

EC-RTTE 1999/EC

ETSI EN 301 489-17 V2.2.1:2012, referencing EN 301 489-1 V1.9.2:2011
 EN 60950-1:2006 + A12:2011

EC-Low Voltage Directive 2014/35/EU

EN 61010-1:2010

EC-EMC Directive 2004/108/EC

EN 61326-1:2013

EN 55011:2009 + A1:2010	EN 61000-4-5:2006
EN 61000-4-2:2009	EN 61000-4-6:2009
EN 61000-4-3:2006 + A1:2008 + A2:2010	EN 61000-4-8:2010
EN 61000-4-4:2004 + AC:2006 + A1:2010	EN 61000-4-11:2004

Certification Laboratory

EC-Low Voltage Directive 2014/35/EU:

TUV SUD America, Minneapolis MN

EC-EMC-Directive 2004/108/EC:

TUV SUD America, Minneapolis MN

European Representative:

BlowerDoor GmbH

MessSysteme für Luftdichtheit

Zum Energie- und Umweltzentrum 1

D-31832 Springe

Germany



Gary D. Nelson, President

The Energy Conservatory May 31, 2017



© BlowerDoor GmbH / 2023

BlowerDoor GmbH MessSysteme für Luftdichtheit • Zum Energie- und Umweltzentrum 1 • D-31832 Springe-Eldagsen
Phone +49 5044 975-40 • Fax +49 5044 975-44 • info@blowerdoor.com • www.blowerdoor.com